

**VACON 100**  
HVAC DRIVES

# APPLICATION MANUAL

# INDEX

Document ID: DPD00491E

Order code: DOC-APP02456+DLUK

Rev. E

Version release date: 21.3.11

Corresponds to application package FW0065V012.vcx

<b>1. Vacon 100 - Startup .....</b>	<b>2</b>
1.1 Startup Wizard.....	2
1.2 PID Mini-Wizard .....	3
1.3 Multi-pump mini-wizard .....	4
<b>2. Keypad of the drive .....</b>	<b>7</b>
2.1 Vacon keypad with graphical display .....	8
2.1.1 Keypad display.....	8
2.1.2 Using the graphical keypad.....	8
2.2 Vacon keypad with text segment display .....	13
2.2.1 Keypad display.....	13
2.2.2 Using the keypad .....	14
2.3 Menu structure.....	16
2.3.1 Quick setup.....	17
2.3.2 Monitor .....	17
2.3.3 Parameters.....	18
2.3.4 Diagnostics .....	18
2.3.5 I/O and hardware.....	20
2.3.6 User settings .....	23
2.3.7 Favourites .....	24
2.3.8 User levels.....	24
<b>3. Vacon HVAC Application.....</b>	<b>26</b>
3.1 Specific functions of Vacon HVAC application .....	26
3.2 Example of control connections .....	27
3.3 HVAC Application - Quick setup parameter group .....	29
3.4 Monitor group.....	31
3.4.1 Multimonitor.....	31
3.4.2 Basic .....	31
3.4.3 Timer functions monitoring .....	32
3.4.4 PID1 controller monitoring .....	33
3.4.5 PID2 controller monitoring .....	33
3.4.6 Multi-pump monitoring.....	33
3.4.7 Fieldbus data monitoring .....	34
3.5 Vacon HVAC Application - Application parameter lists .....	35
3.5.1 Column explanations .....	36
3.5.2 Parameter programming.....	37
3.5.3 Group 3.1: Motor settings .....	41
3.5.4 Group 3.2: Start/Stop setup .....	44
3.5.5 Group 3.3: Control reference settings .....	45
3.5.6 Group 3.4: Ramp & Brakes Setup.....	48
3.5.7 Group 3.5: I/O Configuration .....	49
3.5.8 Group 3.6: Fieldbus Data Mapping.....	56
3.5.9 Group 3.7: Prohibit Frequencies .....	57
3.5.10 Group 3.8: Limit supervisions .....	58
3.5.11 Group 3.9: Protections .....	59
3.5.12 Group 3.10: Automatic reset .....	62
3.5.13 Group 3.11: Timer functions .....	63
3.5.14 Group 3.12: PID-controller 1.....	67

3.5.15 Group 3.13: PID-controller 2.....	73
3.5.16 Group 3.14: Multi-pump .....	75
3.5.17 Group 3.16: Fire mode.....	76
3.5.18 Group 3.17: Application settings .....	77
3.6 HVAC Application - Additional parameter information .....	78
3.7 HVAC Application - Fault tracing .....	104
3.7.1 Fault appears .....	104
3.7.2 Fault history .....	105
3.7.3 Fault codes .....	106

# 1. VACON 100 - STARTUP

## 1.1 STARTUP WIZARD

In the *Startup Wizard*, you will be prompted for essential information needed by the drive so that it can start controlling your process. In the Wizard, you will need the following keypad buttons:

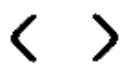
 Left/Right arrows. Use these to easily move between digits and decimals.

 Up/Down arrows. Use these to move between options in menu and to change value.

 OK button. Confirm selection with this button.

 Back/Reset button. Pressing this button, you can return to the previous question in the Wizard. If pressed at the first question, the Startup Wizard will be cancelled.

Once you have connected power to your Vacon 100 frequency converter, follow these instructions to easily set up your drive.

**NOTE:** You can have your AC drive equipped with a keypad with either a graphical or an LCD display.

<b>1</b>	Language selection	Depends on language package
----------	--------------------	-----------------------------

<b>2</b>	Daylight saving*	Russia US EU OFF
<b>3</b>	Time*	hh:mm:ss
<b>4</b>	Day*	dd.mm.
<b>5</b>	Year*	yyyy

\* These questions appear if battery is installed

<b>6</b>	Run Startup Wizard?	Yes No
----------	---------------------	-----------

Push the OK button unless you want to set all parameter values manually.

<b>7</b>	Choose your process	Pump Fan
----------	---------------------	-------------

<b>8</b>	Set value for <i>Motor nominal speed</i> (according to nameplate)	Range: 24...19,200 rpm
<b>9</b>	Set value for <i>Motor nominal current</i> (according to nameplate)	Range: Varies
<b>10</b>	Set value for <i>Minimum frequency</i>	Range: 0.00...50.00 Hz
<b>11</b>	Set value for <i>Maximum frequency</i>	Range: 0.00...320.00 Hz

Now the Startup Wizard is done.

The Startup Wizard can be re-initiated by activating the parameter *Restore factory defaults* (par. P6.5.1) in the *Parameter backup* submenu (M6.5) OR with parameter P1.19 in the Quick setup menu.

### 1.2 PID MINI-WIZARD

The *PID mini wizard* is activated in the *Quick Setup* menu. This wizard presupposes that you are going to use the PID controller in the "one feedback / one setpoint" mode. The control place will be I/O A and the default process unit '%'.  
The *PID mini wizard* asks for the following values to be set:

<b>1</b>	Process unit selection	(Several selections. See par. P3.12.1.4)
----------	------------------------	------------------------------------------

If any other process unit than '%' is selected the following questions appear: If not the Wizard will directly jump to step 5.

<b>2</b>	Process unit min	
<b>3</b>	Process unit max	
<b>4</b>	Process unit decimals	0...4

<b>5</b>	Feedback 1 source selection	See page 70 for selections.
----------	-----------------------------	-----------------------------

If one of the analogue input signals is selected the question 6 appears. Otherwise you will be taken to question 7.

<b>6</b>	Analogue input signal range	0 = 0...10V / 0...20mA 1 = 2...10V / 4...20mA See page 51.
----------	-----------------------------	------------------------------------------------------------------

<b>7</b>	Error inversion	0 = Normal 1 = Inverted
<b>8</b>	Setpoint source selection	See page 68 for selections.

If one of the analogue input signals is selected the question 9 appears. Otherwise you will be taken to question 11.

If either of the options Keypad Setpoint 1 or 2 is chosen the question 10 will appear.

<b>9</b>	Analogue input signal range	0 = 0...10V / 0...20mA 1 = 2...10V / 4...20mA See page 51.
<b>10</b>	Keypad setpoint	

<b>11</b>	Sleep function?	No Yes
-----------	-----------------	-----------

If option 'Yes' is selected you will be prompted for three more values:

<b>12</b>	Sleep frequency limit 1	0.00...320.00 Hz
<b>13</b>	Sleep delay 1	0...3000 s
<b>14</b>	Wake-up level 1	Range depends on selected process unit.

### 1.3 MULTI-PUMP MINI-WIZARD

The Multi-Pump mini-wizard asks the most important questions for setting up a Multi-Pump system. The PID mini-wizard always precedes the Multi-Pump mini-wizard. The keypad will guide you through the questions as in chapter 1.2 then to be followed by the set of questions below:

<b>15</b>	Number of motors	1...4
<b>16</b>	Interlock function	0 = Not used 1 = Enabled
<b>17</b>	Autochange	0 = Disabled 1 = Enabled

If Autochange function is enabled the following three questions will appear. If Autochange will not be used the Wizard jumps directly to question 21.

<b>18</b>	Include FC	0 = Disabled 1 = Enabled
<b>19</b>	Autochange interval	0.0...3000.0 h
<b>20</b>	Autochange: Frequency limit	0.00...50.00 Hz

<b>21</b>	Bandwidth	0...100%
<b>22</b>	Bandwidth delay	0...3600 s

After this, the keypad will show the digital input and relay output configuration recommended by the application. Write these values down for future reference.



## 2. KEYPAD OF THE DRIVE

The control keypad is the interface between the Vacon 100 frequency converter and the user. With the control keypad it is possible to control the speed of a motor, to supervise the state of the equipment and to set the frequency converter's parameters.

There are two keypad types you can choose for your user interface: Keypad with graphical display and keypad with text segment display (text keypad).

The button section of the keypad is identical for both keypad types.

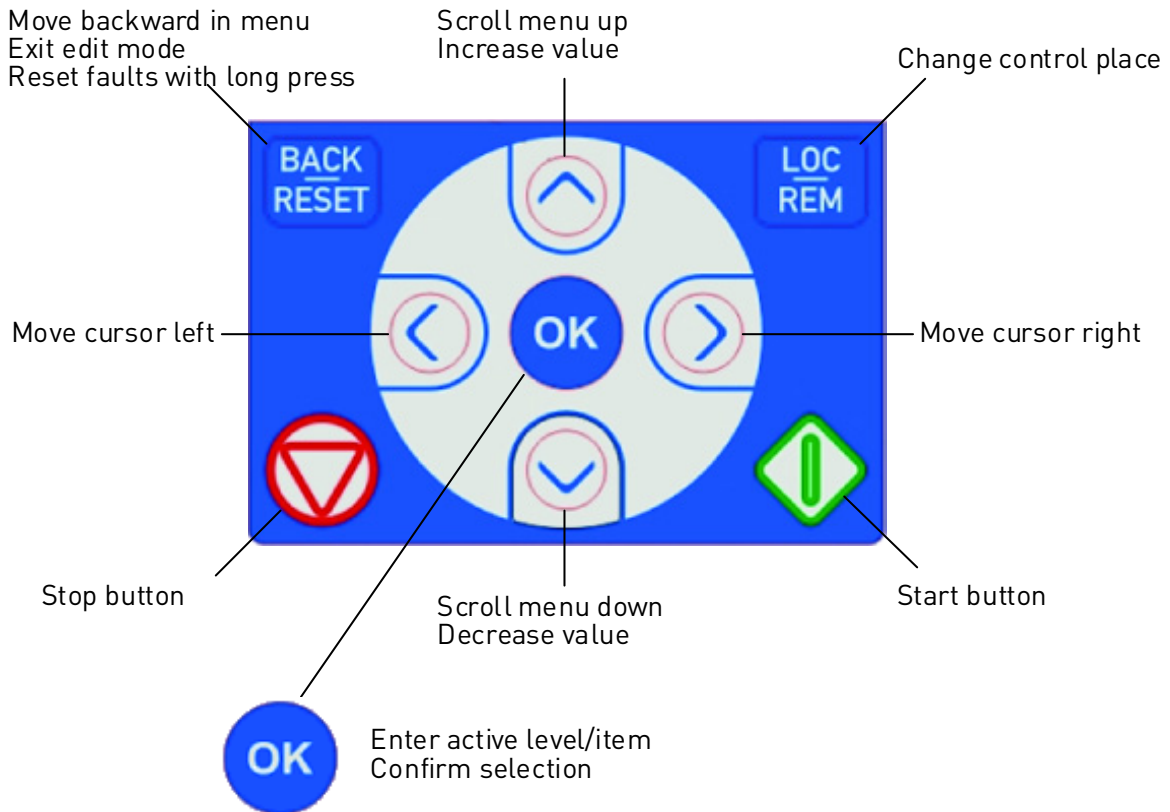

Figure 1. Keypad buttons

## 2.1 VACON KEYPAD WITH GRAPHICAL DISPLAY

The graphical keypad features an LCD display and 9 buttons.

### 2.1.1 KEYPAD DISPLAY

The keypad display indicates the status of the motor and the drive and any irregularities in motor or drive functions. On the display, the user sees information about his present location in the menu structure and the item displayed.

#### 2.1.1.1 Main menu

The data on the control keypad are arranged in menus and submenus. Use the Up and Down arrows to move between the menus. Enter the group/item by pressing the OK button and return to the former level by pressing the Back/Reset button.

The *Location field* indicates your current location. The *Status field* gives information about the present status of the drive. See Figure 1.

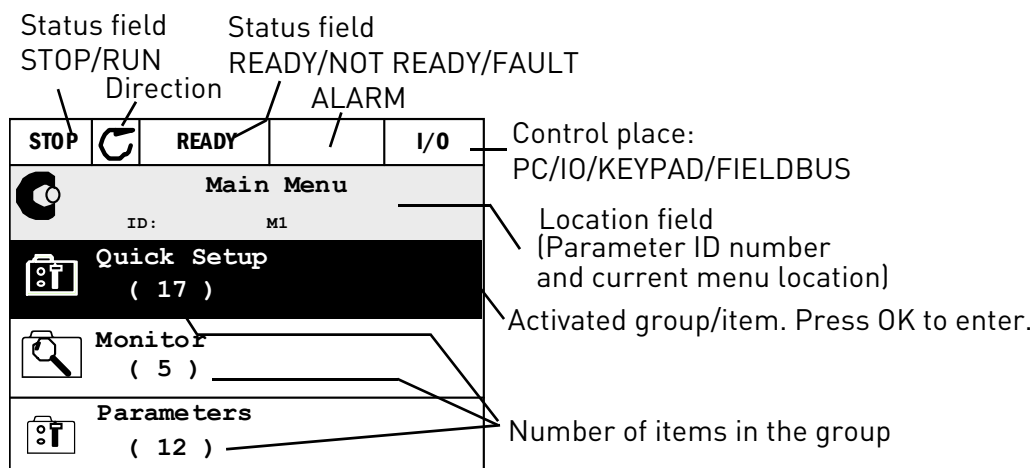

Figure 2. Main menu

### 2.1.2 USING THE GRAPHICAL KEYPAD

#### 2.1.2.1 Editing values

Change value of a parameter following the procedure below:

1. Locate the parameter.
2. Enter the *Edit* mode.
3. Set new value with the arrow buttons up/down. You can also move from digit to digit with the arrow buttons left/right if the value is numerical and change then the value with the arrow buttons up/down.
4. Confirm change with OK button or ignore change by returning to previous level with Back/Reset button.

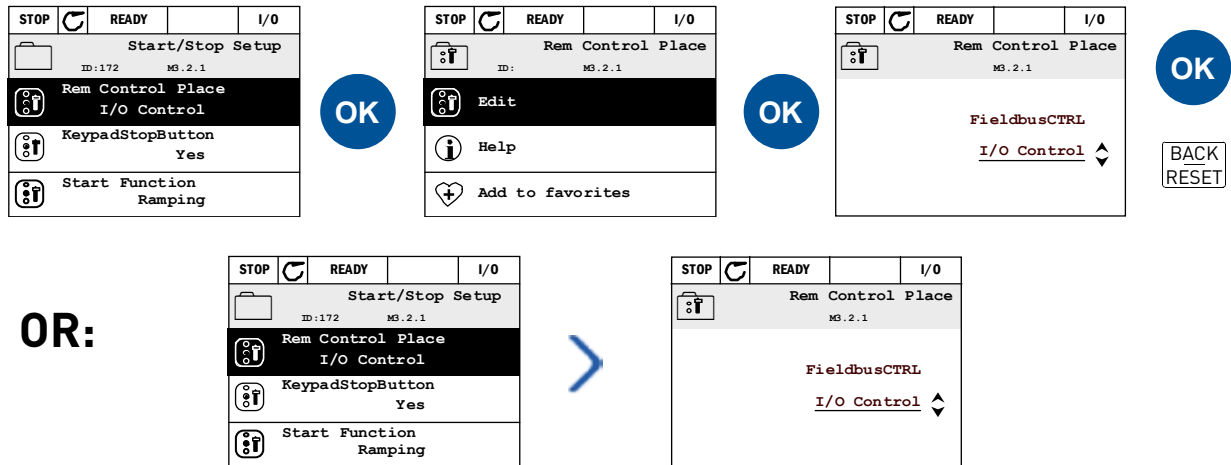

Figure 3. Editing values on graphical keypad

### 2.1.2.2 Resetting fault

Instructions for how to reset a fault can be found in chapter 3.7.1 on page 104.

### 2.1.2.3 Local/Remote control button

The LOC/REM button is used for two functions: to quickly access the Control page and to easily change between the Local (Keypad) and Remote control places.

#### Control places

The *control place* is the source of control where the drive can be started and stopped. Every control place has its own parameter for selecting the frequency reference source. In the HVAC drive, the *Local control place* is always the keypad. The *Remote control place* is determined by parameter P1.15 (I/O or Fieldbus). The selected control place can be seen on the status bar of the keypad.

#### Remote control place

I/O A, I/O B and Fieldbus can be used as remote control places. I/O A and Fieldbus have the lowest priority and can be chosen with parameter P3.2.1 (*Rem Control Place*). I/O B, again, can bypass the remote control place selected with parameter P3.2.1 using a digital input. The digital input is selected with parameter P3.5.1.5 (*I/O B Ctrl Force*).

#### Local control

Keypad is always used as control place while in local control. Local control has higher priority than remote control. Therefore, if, for example, bypassed by parameter P3.5.1.5 through digital input while in *Remote*, the control place will still switch to Keypad if *Local* is selected. Switching between Local and Remote Control can be done by pressing the Loc/Rem-button on the keypad or by using the "Local/Remote" (ID211) parameter.

#### Changing control places

Change of control place from *Remote* to *Local* (keypad).

1. Anywhere in the menu structure, push the *Loc/Rem* button.
2. Push the *Arrow up* or the *Arrow down* button to select *Local/Remote* and confirm with the *OK* button.
3. On the next display, select *Local* or *Remote* and again confirm with the *OK* button.
4. The display will return to the same location as it was when the *Loc/Rem* button was pushed. However, if the Remote control place was changed to Local (Keypad) you will be prompted for keypad reference.

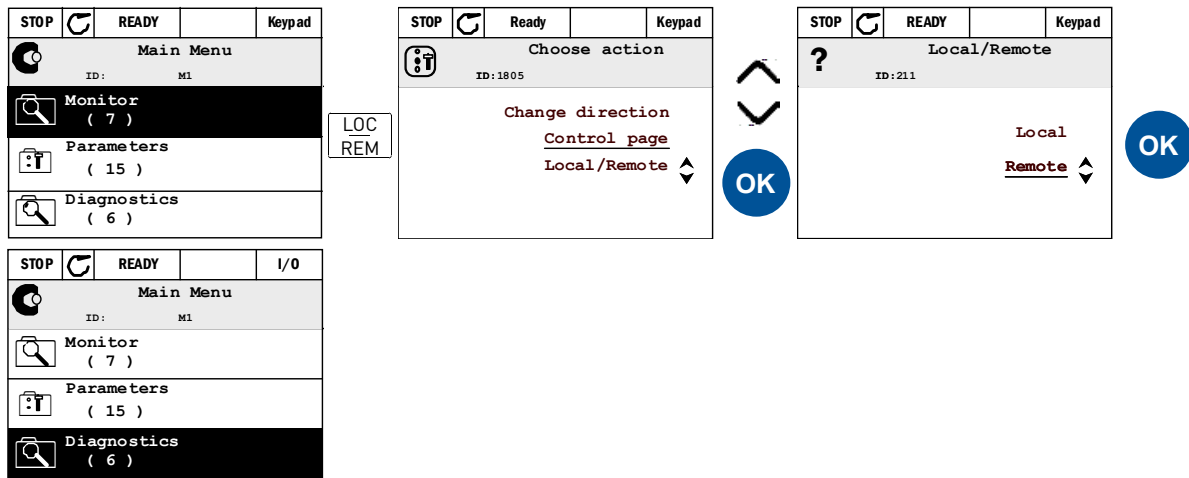

Figure 4. Changing control places

### Accessing the control page

The *Control page* is meant for easy operation and monitoring of the most essential values.

1. Anywhere in the menu structure, push the *Loc/Rem* button.
2. Push the *Arrow up* or the *Arrow down* button to select *Control page* and confirm with the *OK* button.
3. The control page appears  
 If keypad control place and keypad reference are selected to be used you can set the *Keypad reference* after having pressed the *OK* button. If other control places or reference values are used the display will show Frequency reference which is not editable. The other values on the page are Multimonitoring values. You can choose which values appear here for monitoring (for this procedure, see page 17).

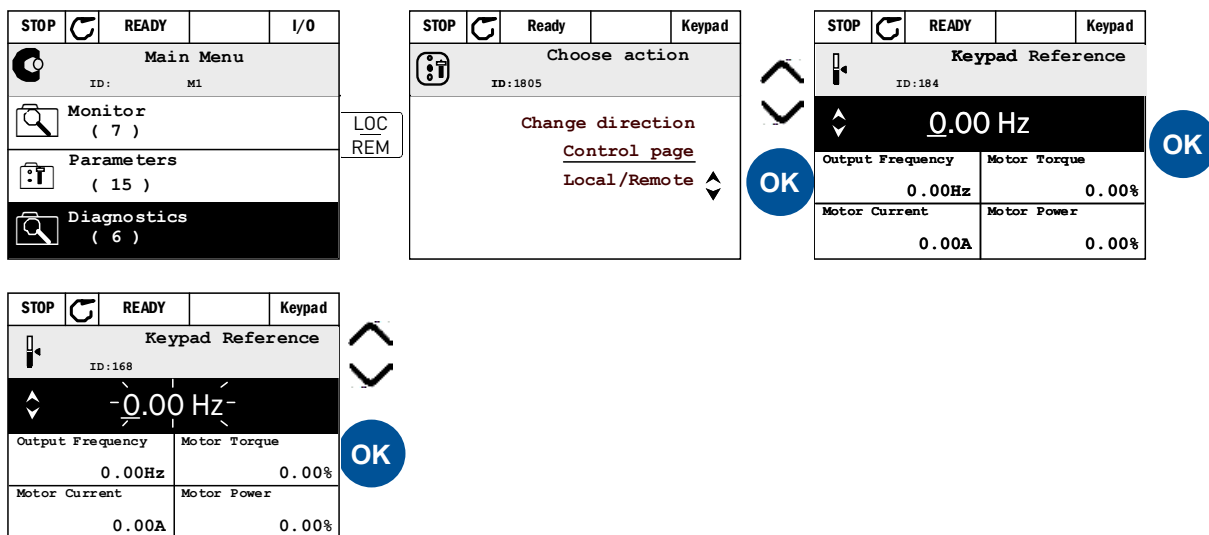

Figure 5. Accessing Control page

### 2.1.2.4 Copying parameters

**NOTE:** This feature is available in Advanced commissioning keypad only.

The parameter copy function can be used to copy parameters from one drive to another.

The parameters are first saved to the keypad, then the keypad is detached and connected to another drive. Finally the parameters are downloaded to the new drive restoring them from the keypad.

Before any parameters can successfully be copied from one drive to another the drive has to be stopped when the parameters are downloaded.

- First go into *User settings* menu and locate the *Parameter backup* submenu. In the *Parameter backup* submenu, there are three possible functions to be selected:
- *Restore factory defaults* will re-establish the parameter settings originally made at the factory.
- By selecting *Save to keypad* you can copy all parameters to the keypad.
- *Restore from keypad* will copy all parameters from keypad to a drive.

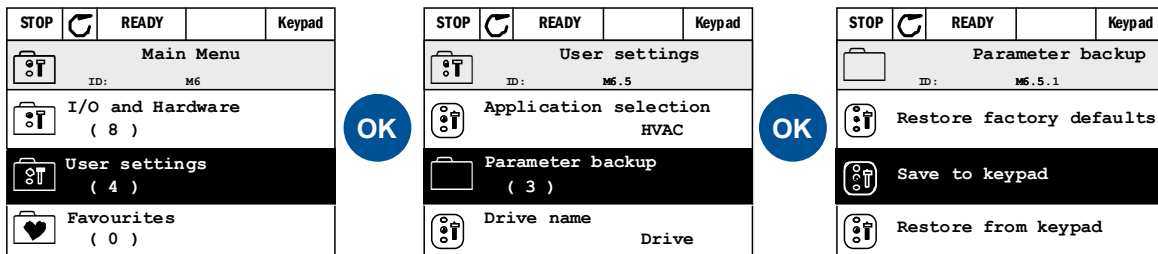

Figure 6. Parameter copy

**NOTE:** If the keypad is changed between drives of different sizes, the copied values of these parameters will not be used:

- Motor nominal current (P3.1.1.4)
- Motor nominal voltage (P3.1.1.1)
- Motor nominal speed (P3.1.1.3)
- Motor nominal power (P3.1.1.6)
- Motor nominal frequency (P3.1.1.2)
- Motor cos phi (P3.1.1.5)
- Switching frequency (P3.1.2.1)
- Motor current limit (P3.1.1.7)
- Stall current limit (P3.9.12)
- Stall time limit (P3.9.13)
- Stall frequency (P3.9.14)
- Maximum frequency (P3.3.2)

2.1.2.5 Help texts

The graphical keypad features instant help and information displays for various items. All parameters offer an instant help display. Select Help and press the OK button. Text information is also available for faults, alarms and the startup wizard.

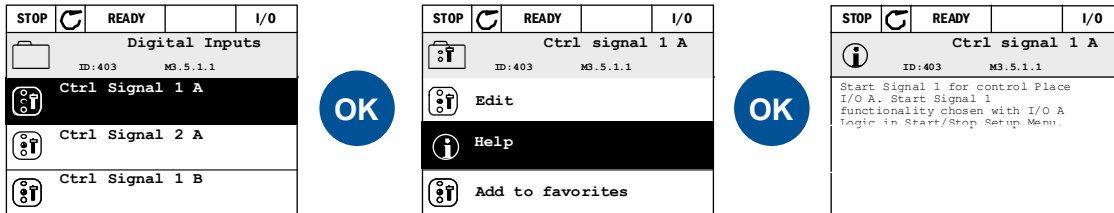

Figure 7. Help text example

2.1.2.6 Adding item to favourites

You might need to refer to certain parameter values or other items often. Instead of locating them one by one in the menu structure, you may want to add them to a folder called *Favourites* where they can easily be reached.

To remove an item from the Favourites, see chapter 2.3.7.

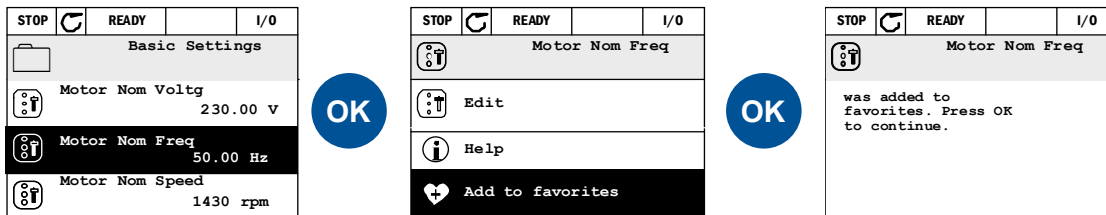

Figure 8. Adding item to Favourites

## 2.2 VACON KEYPAD WITH TEXT SEGMENT DISPLAY

You can also choose a *Keypad with text segment display* (Text keypad) for your user interface. It has mainly the same functionalities as the keypad with graphical display although some of these are somewhat limited.

### 2.2.1 KEYPAD DISPLAY

The keypad display indicates the status of the motor and the drive and any irregularities in motor or drive functions. On the display, the user sees information about his present location in the menu structure and the item displayed. If the text on the text line is too long to fit in the display, the text will scroll from left to right to reveal the whole text string.

#### 2.2.1.1 Main menu

The data on the control keypad are arranged in menus and submenus. Use the Up and Down arrows to move between the menus. Enter the group/item by pressing the OK button and return to the former level by pressing the Back/Reset button.

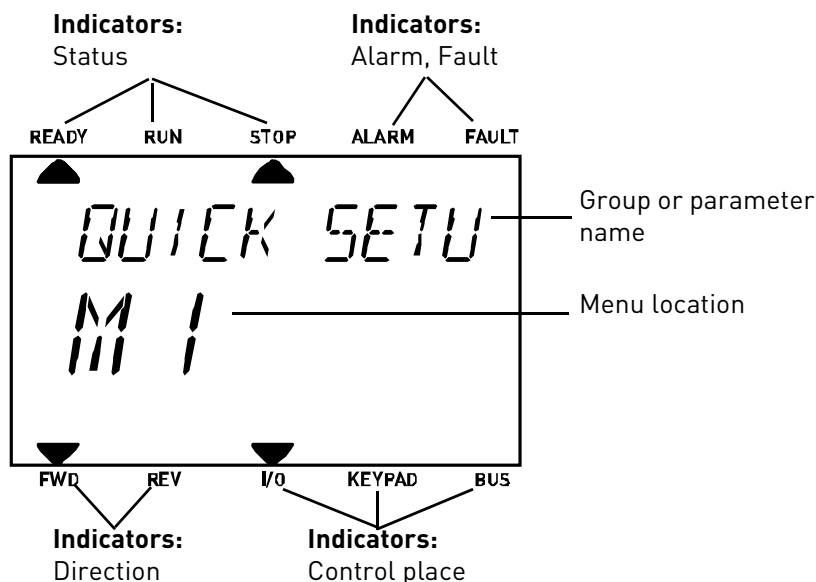

## 2.2.2 USING THE KEYPAD

### 2.2.2.1 Editing values

Change value of a parameter following the procedure below:

1. Locate the parameter.
2. Enter the Edit mode by pressing OK.
3. Set new value with the arrow buttons up/down. You can also move from digit to digit with the arrow buttons left/right if the value is numerical and change then the value with the arrow buttons up/down.
4. Confirm change with OK button or ignore change by returning to previous level with Back/Reset button.

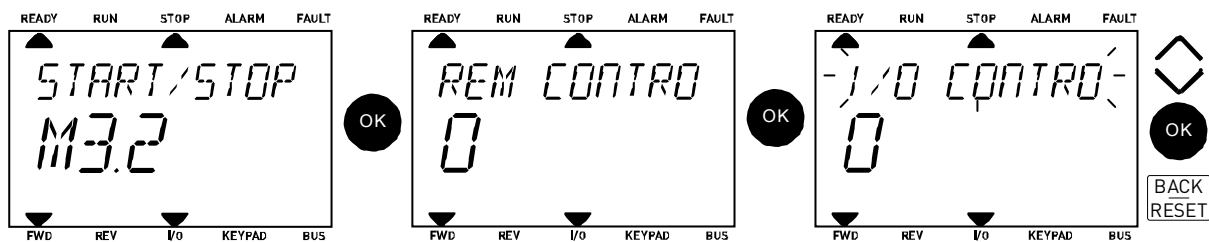

Figure 9. Editing values

### 2.2.2.2 Resetting fault

Instructions for how to reset a fault can be found in chapter 3.7.1 on page 104.

### 2.2.2.3 Local/Remote control button

The LOC/REM button is used for two functions: to quickly access the Control page and to easily change between the Local (Keypad) and Remote control places.

#### Control places

The *control place* is the source of control where the drive can be started and stopped. Every control place has its own parameter for selecting the frequency reference source. In the HVAC drive, the *Local control place* is always the keypad. The *Remote control place* is determined by parameter P1.15 (I/O or Fieldbus). The selected control place can be seen on the status bar of the keypad.

#### Remote control place

I/O A, I/O B and Fieldbus can be used as remote control places. I/O A and Fieldbus have the lowest priority and can be chosen with parameter P3.2.1 (*Rem Control Place*). I/O B, again, can bypass the remote control place selected with parameter P3.2.1 using a digital input. The digital input is selected with parameter P3.5.1.5 (*I/O B Ctrl Force*).

#### Local control

Keypad is always used as control place while in local control. Local control has higher priority than remote control. Therefore, if, for example, bypassed by parameter P3.5.1.5 through digital input while in *Remote*, the control place will still switch to Keypad if *Local* is selected. Switching between Local and Remote Control can be done by pressing the Loc/Rem-button on the keypad or by using the "Local/Remote" (ID211) parameter.

#### Changing control places

Change of control place from *Remote* to *Local* (keypad).

1. Anywhere in the menu structure, push the *Loc/Rem* button.
2. Using the arrow buttons, select *Local/Remote* and confirm with the *OK* button.
3. On the next display, select *Local* or *Remote* and again confirm with the *OK* button.
4. The display will return to the same location as it was when the *Loc/Rem* button was pushed. However, if the *Remote* control place was changed to *Local (Keypad)* you will be prompted for keypad reference.

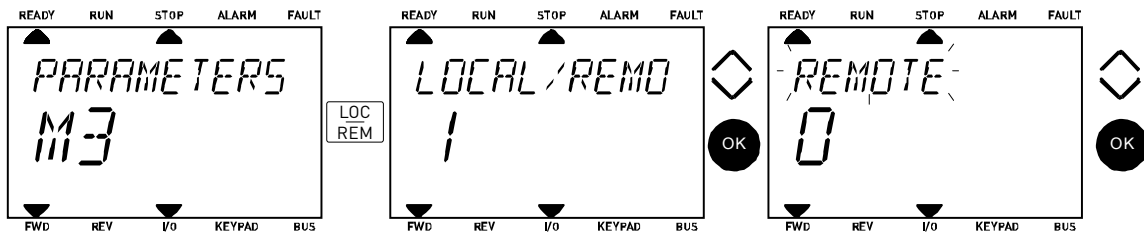

Figure 10. Changing control places

### Accessing the control page

The *Control page* is meant for easy operation and monitoring of the most essential values.

1. Anywhere in the menu structure, push the *Loc/Rem* button.
2. Push the *Arrow up* or the *Arrow down* button to select *Control page* and confirm with the *OK* button.
3. The control page appears  
 If keypad control place and keypad reference are selected to be used you can set the *Keypad reference* after having pressed the *OK* button. If other control places or reference values are used the display will show *Frequency reference* which is not editable.

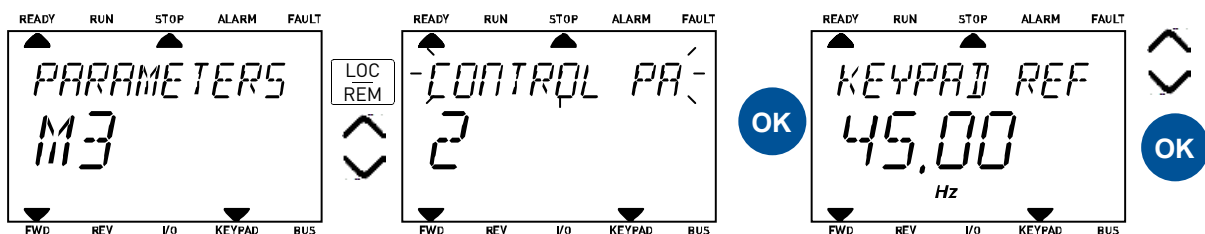

Figure 11. Accessing Control page

## 2.3 MENU STRUCTURE

Click on and select the item you wish to receive more information about (electronic manual).

<b>Quick setup</b>	See chapter 3.3.
<b>Monitor</b>	Multi-monitor*
	Basic
	Timer functions
	PID Controller 1
	PID Controller 2
	Multi-Pump
	Fieldbus data
<b>Parameters</b>	See chapter 3.
<b>Diagnostics</b>	Active faults
	Reset faults
	Fault history
	Total counters
	Trip counters
	Software info
<b>I/O and hardware</b>	Basic I/O
	Slot D
	Slot E
	Real time clock
	Power unit settings, Fan control
	Keypad
	RS-485
	Ethernet
<b>User settings</b>	Language selections
	Application selection
	Parameter backup*
	Drive name
<b>Favourites*</b>	See chapter 2.1.2.6

\*. Not available in text keypad

*Table 1. Keypad menus*

### 2.3.1 QUICK SETUP

The Quick Setup Menu includes the minimum set of most commonly used parameters during installation and commissioning. More detailed information on the parameters of this group you will find in chapter 3.3.

### 2.3.2 MONITOR

#### Multi-monitor

**NOTE:** This menu is not available in text keypad.

On the multi-monitor page, you can collect nine values that you wish to monitor.

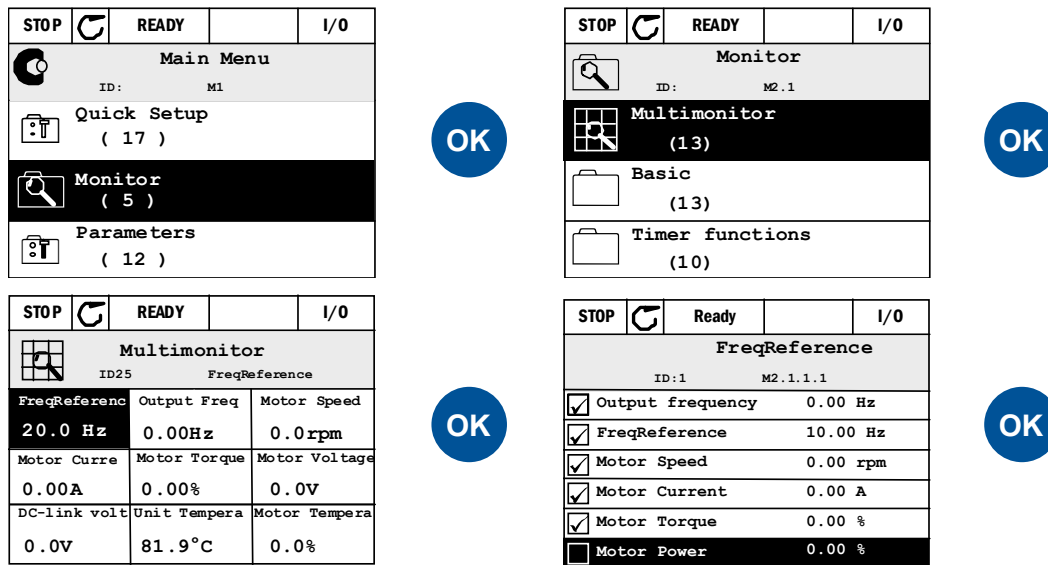

Figure 12. Multi-monitoring page

Change the monitored value by activating the value cell (with arrow buttons left/right) and clicking OK. Then choose a new item on the Monitoring values list and click OK again.

#### Basic

The basic monitoring values are the actual values of selected parameters and signals as well as statuses and measurements.

#### Timer functions

Monitoring of timer functions and the Real Time Clock. See chapter 3.4.3.

#### PID Controller 1

Monitoring of PID controller values. See chapters 3.4.4 and 3.4.5.

#### PID Controller 2

Monitoring of PID controller values. See chapters 3.4.4 and 3.4.5.

#### Multi-Pump

Monitoring of values related to the use of several drives. See chapter 3.4.6.

#### Fieldbus data

Fieldbus data shown as monitor values for debugging purposes at e.g. fieldbus commissioning. See chapter 3.4.7.

### 2.3.3 PARAMETERS

Through this submenu, you can reach the application parameter groups and parameters. More information on parameters in chapter 3.

### 2.3.4 DIAGNOSTICS

Under this menu, you can find *Active faults*, *Reset faults*, *Fault history*, *Counters* and *Software info*.

#### 2.3.4.1 Active faults

Menu	Function	Note
<b>Active faults</b>	When a fault/faults appear(s), the display with the name of the fault starts to blink. Press OK to return to the Diagnostics menu. The <i>Active faults</i> submenu shows the number of faults. Select the fault and push OK to see the fault-time data.	The fault remains active until it is cleared with the Reset button (push for 2 s) or with a reset signal from the I/O terminal or fieldbus or by choosing <i>Reset faults</i> (see below). The memory of active faults can store the maximum of 10 faults in the order of appearance.

#### 2.3.4.2 Reset faults

Menu	Function	Note
<b>Reset faults</b>	In this menu you can reset faults. For closer instructions, see chapter 3.7.1.	 <b>CAUTION!</b> Remove external Control signal before resetting the fault to prevent unintentional restart of the drive.

#### 2.3.4.3 Fault history

Menu	Function	Note
<b>Fault history</b>	40 latest faults are stored in the Fault history.	Entering the Fault history and clicking OK on the selected fault shows the fault time data (details).

#### 2.3.4.4 Total counters

Code	Parameter	Min	Max	Unit	Default	ID	Description
V4.4.1	Energy counter			Varies		2291	Amount of energy taken from supply network. No reset.
V4.4.3	Operating time (graphical keypad)			a d hh:min		2298	Control unit operating time
V4.4.4	Operating time (text keypad)			a			Control unit operating time in total years
V4.4.5	Operating time (text keypad)			d			Control unit operating time in total days
V4.4.6	Operating time (text keypad)			hh:min:ss			Control unit operating time in hours, minutes and seconds
V4.4.7	Run time (graphical keypad)			a d hh:min		2293	Motor running time

V4.4.8	Run time (text keypad)			a			Motor running time in total years
V4.4.9	Run time (text keypad)			d			Motor running time in total days
V4.4.10	Run time (text keypad)			hh:min:ss			Motor running time in hours, minutes and seconds
V4.4.11	Power on time (graphical keypad)			a d hh:min		2294	Amount of time the power unit has been powered so far. No reset.
V4.4.12	Power on time (text keypad)			a			Power on time in total years
V4.4.13	Power on time (text keypad)			d			Power on time in total days
V4.4.14	Power on time (text keypad)			hh:min:ss			Power on time in hours, minutes and seconds
V4.4.15	Start command counter					2295	The number of times the power unit has been started.

*Table 2. Diagnostics menu, Total counters parameters*

#### 2.3.4.5 Trip counters

Code	Parameter	Min	Max	Unit	Default	ID	Description
V4.5.1	Energy trip counter			Varies		2296	Resettable energy counter.
V4.5.3	Operating time			a d hh:min		2299	Resettable.

*Table 3. Diagnostics menu, Trip counters parameters*

#### 2.3.4.6 Software info

Code	Parameter	Min	Max	Unit	Default	ID	Description
V4.6.1	Software package (graphical keypad)						
V4.6.2	Software package ID (text keypad)						
V4.6.3	Software package version (text keypad)						
V4.6.4	System load	0	100	%		2300	Load on control unit CPU.
V4.6.5	Application name (graphical keypad)						Name of application
V4.6.6	Application ID						
V4.6.7	Application version						

*Table 4. Diagnostics menu, Software info parameters*

### 2.3.5 I/O AND HARDWARE

Various options-related settings are located in this menu.

#### 2.3.5.1 Basic I/O

Monitor here the statuses of inputs and outputs.

Code	Parameter	Min	Max	Unit	Default	ID	Description
V5.1.1	Digital input 1	0	1				Status of digital input signal
V5.1.2	Digital input 2	0	1				Status of digital input signal
V5.1.3	Digital input 3	0	1				Status of digital input signal
V5.1.4	Digital input 4	0	1				Status of digital input signal
V5.1.5	Digital input 5	0	1				Status of digital input signal
V5.1.6	Digital input 6	0	1				Status of digital input signal
V5.1.7	Analogue input 1 mode	1	3				Shows the selected (with jumper) mode for Analogue input signal 1 = 0...20mA 3 = 0...10V
V5.1.8	Analogue input 1	0	100	%			Status of analogue input signal
V5.1.9	Analogue input 2 mode	1	3				Shows the selected (with jumper) mode for Analogue input signal 1 = 0...20mA 3 = 0...10V
V5.1.10	Analogue input 2	0	100	%			Status of analogue input signal
V5.1.11	Analogue output 1 mode	1	3				Shows the selected (with jumper) mode for Analogue output signal 1 = 0...20mA 3 = 0...10V
V5.1.12	Analogue output 1	0	100	%			Status of analogue output signal

Table 5. I/O and Hardware menu, Basic I/O parameters

#### 2.3.5.2 Option board slots

The parameters of this group depend on the option board installed. If no option board is placed in slots D or E, no parameters are visible. See chapter 3.5.2 for the location of the slots.

As an option board is removed, info text F39 *Device removed* will appear on the display. See Table 57.

Menu	Function	Note
<b>Slot D</b>	Settings	Option board related settings.
	Monitoring	Monitor option board-related info.
<b>Slot E</b>	Settings	Option board related settings.
	Monitoring	Monitor option board-related info.

### 2.3.5.3 Real time clock

Code	Parameter	Min	Max	Unit	Default	ID	Description
V5.4.1	Battery state	1	3		2	2205	Status of battery. 1 = Not installed 2 = Installed 3 = Change battery
V5.4.2	Time			hh:mm:ss		2201	Current time of day
V5.4.3	Date			dd.mm.		2202	Current date
V5.4.4	Year			yyyy		2203	Current year
V5.4.5	Daylight saving	1	4		1	2204	Daylight saving rule 1 = Off 2 = EU 3 = US 4 = Russia

Table 6. I/O and Hardware menu, Real time clock parameters

### 2.3.5.4 Power unit settings, Fan control

Code	Parameter	Min	Max	Unit	Default	ID	Description
V5.5.1.2	Fan speed	0	100	%	0	848	
V5.5.1.4	Fan stop	0	1		0		If enabled, the fan will stop after 5 minutes when the drive is in Ready state. 0 = Disabled 1 = Enabled

Table 7. Power unit settings, Fan control

### 2.3.5.5 Keypad

Code	Parameter	Min	Max	Unit	Default	ID	Description
P5.6.1	Timeout time	0	60	min	0		Time after which the display returns to page defined with parameter P5.6.2. 0 = Not used
P5.6.2	Default page	0	4		0		0 = None 1 = Enter menu index 2 = Main menu 3 = Control page 4 = Multimonitor
P5.6.3	Menu index						Set menu index for desired page and activate with parameter P5.6.2 = 1.
P5.6.4	Contrast (graphic keypad)	30	70	%	50		Set contrast of the display (30...70%).
P5.6.5	Backlight time	0	60	min	5		Set the time until the backlight of the display turns off (0...60 min). If set to 0 s, backlight is always on.

Table 8. I/O and Hardware menu, Keypad parameters

### 2.3.5.6 Fieldbus

Parameters related to different fieldbus boards can also be found in the *I/O and Hardware* menu. These parameters are explained in more detail in the respective fieldbus manual.

Submenu level 1	Submenu level 2	Submenu level 3
<b>RS-485</b>	Common settings	Protocol
	Modbus RTU	Modbus parameters
		Modbus monitoring
	N2	N2 parameters
		N2 monitoring
	BACNetMSTP	BACNetMSTP parameters
BACNetMSTP monitoring		
<b>Ethernet</b>	Common settings	
	Modbus/TCP	Modbus/TCP parameters
		Modbus/TCP monitoring
	BACnetIP	BACnetIP parameters
		BACnetIP monitoring

2.3.6 USER SETTINGS

Code	Parameter	Min	Max	Unit	Default	ID	Description
P6.1	Language selections	Varies	Varies		Varies	802	Depends on language package.
P6.2	Application selection					801	
M6.5	Parameter backup	See chapter 2.3.6.1 below.					
P6.7	Drive name						Give name of drive if needed.

Table 9. User settings menu, General settings

2.3.6.1 Parameter backup

Code	Parameter	Min	Max	Unit	Default	ID	Description
P6.5.1	Restore factory defaults					831	Restores default parameter values and initiates the Startup Wizard
P6.5.2	Save to keypad*	0	1		0		Save parameter values to keypad to e.g. copy them to another drive. 0 = No 1 = Yes
P6.5.3	Restore from keypad*						Load parameter values from keypad to the drive.

\*. Only available with graphical keypad

Table 10. User settings menu, Parameter backup parameters

### 2.3.7 FAVOURITES

**NOTE:** This menu is not available in text keypad.

Favourites are typically used to collect a set of parameters or monitoring signals from any of the keypad menus. You can add items or parameters to the Favourites folder, see chapter 2.1.2.6.

To remove an item or a parameter from the Favourites folder, do the following:

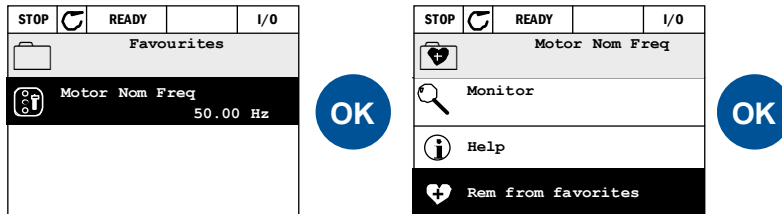

### 2.3.8 USER LEVELS

User level parameters are intended to restrict the visibility of parameters and to prevent unauthorized and inadvertent parameterization on the keypad.

Code	Parameter	Min	Max	Unit	Default	ID	Description
P8.1	User level	0	1		0	1194	0 = Normal 1 = Monitoring In monitoring level only the Monitor, Favourites and User Levels menus are visible in the main menu.
P8.2	Access code	0	9		0	2362	If set to other value than 0 before switching to monitoring when e.g. user level <i>Normal</i> is active, the access code will be asked when trying to switch back to <i>Normal</i> . Can therefore be used to prevent unauthorized parameterization on the keypad.

Table 11. User level parameters

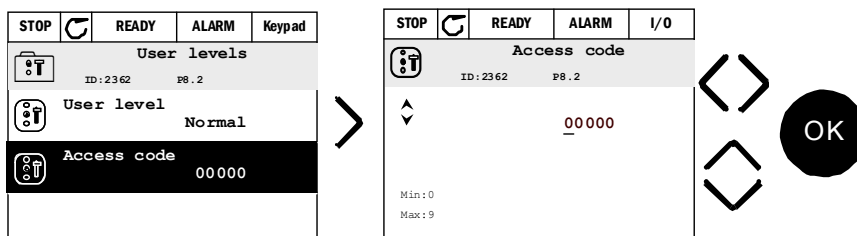



## 3. VACON HVAC APPLICATION

The Vacon HVAC drive contains a preloaded application for instant use.

The parameters of this application are listed in chapter 3.5 of this manual and explained in more detail in chapter 3.6.

### 3.1 SPECIFIC FUNCTIONS OF VACON HVAC APPLICATION

The Vacon HVAC application is an easy-to-use application for not only basic Pump and Fan applications where only one motor and one drive is needed but also offers extensive possibilities for PID control.

#### Features

- **Start-Up Wizard** for extremely fast setup for basic pump or fan applications
- **Mini-Wizards** to ease the setup of applications
- **Loc/Rem button** for easy change between Local (keypad) and Remote control place. The remote control place is selectable by parameter (I/O or Fieldbus)
- **Control page** for easy operation and monitoring of the most essential values.
- **Run interlock** input (Damper interlock). Drive will not start before this input is activated.
- Different **pre-heat modes** used to avoid condensation problems
- **Maximum output frequency 320Hz**
- **Real-time clock and timer functions** available (optional battery required). Possible to program 3 time channels to achieve different functions on the drive (e.g. Start/Stop and Preset frequencies)
- **External PID-controller** available. Can be used to control e.g. a valve using the drive's I/O
- **Sleep mode function** which automatically enables and disables drive running with user defined levels to save energy.
- **2-zone PID-controller** (2 different feedback signals; minimum and maximum control)
- **Two setpoint sources** for the PID-control. Selectable with digital input
- **PID setpoint boost function.**
- **Feedforward function** to improve the response to the process changes
- **Process value supervision**
- **Multi-Pump control**
- **Pressure loss compensation** for compensating pressure losses in the pipework e.g. when sensor is incorrectly placed near the pump or fan

3.2 EXAMPLE OF CONTROL CONNECTIONS

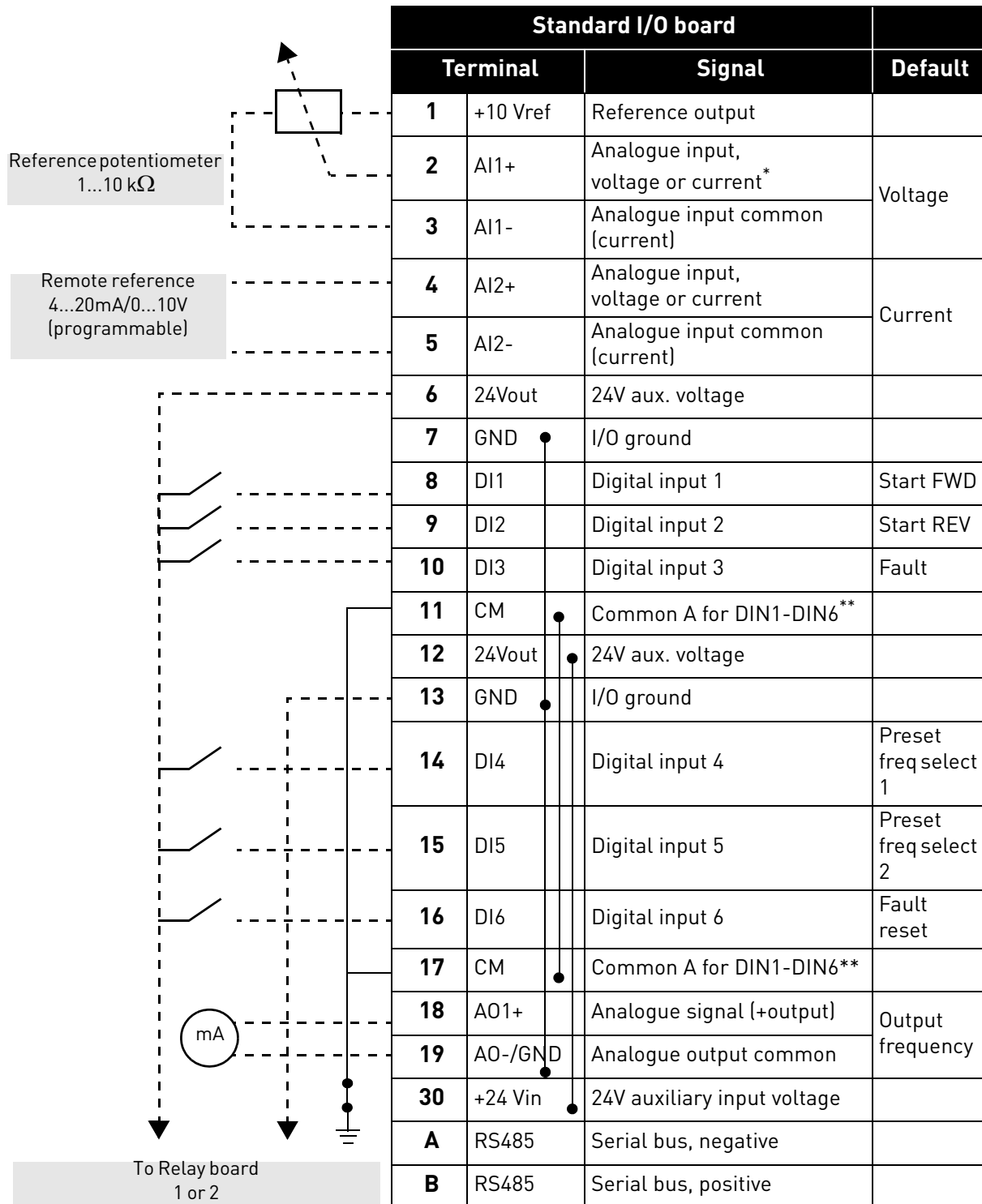

\*Selectable with DIP switches, see Vacon 100 Installation Manual

\*\*Digital inputs can be isolated from ground. See Installation Manual.

Table 12. Connection example, standard I/O board

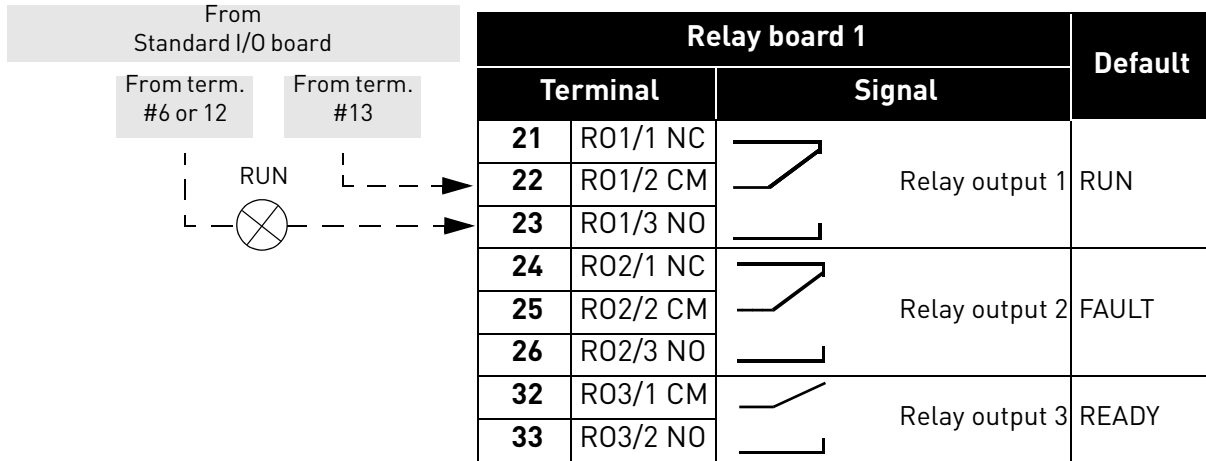

Table 13. Connection example, Relay board 1

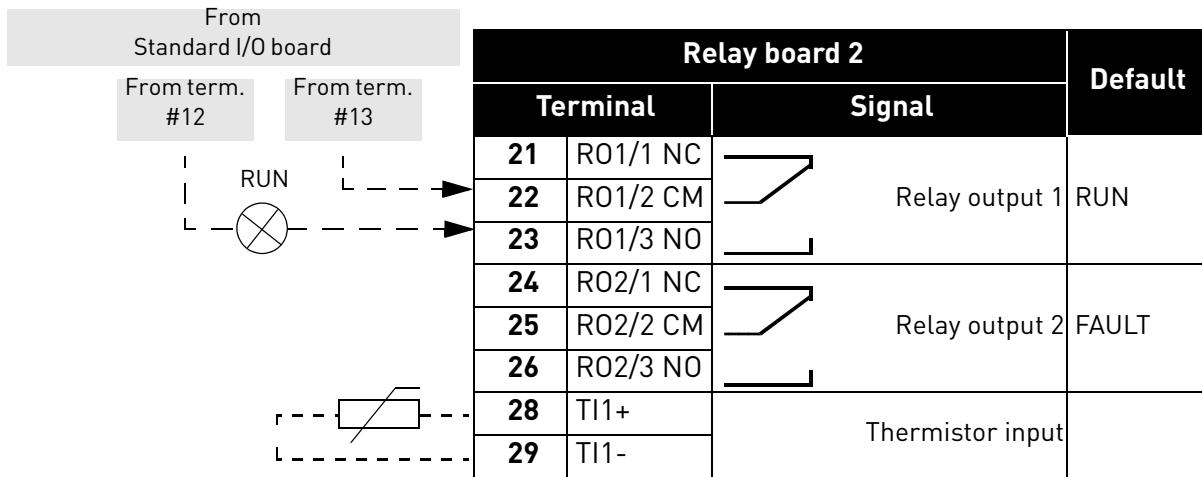

Table 14. Connection example, Relay board 2

### 3.3 HVAC APPLICATION - QUICK SETUP PARAMETER GROUP

The Quick Setup parameter group is a collection of parameters that are most commonly used during installation and commissioning. They are collected in the first parameter group so that they can be found fast and easily. They can, however, be also reached and edited in their actual parameter groups. Changing a parameter value in the Quick setup group also changes the value of this parameter in its actual group.

Code	Parameter	Min	Max	Unit	Default	ID	Description
P1.1	Motor nominal voltage	Varies	Varies	V	Varies	110	Find this value $U_n$ on the rating plate of the motor. See page 41.
P1.2	Motor nominal frequency	8.00	320.00	Hz	50.00	111	Find this value $f_n$ on the rating plate of the motor. See page 41.
P1.3	Motor nominal speed	24	19200	rpm	1420	112	Find this value $n_n$ on the rating plate of the motor.
P1.4	Motor nominal current	Varies	Varies	A	Varies	113	Find this value $I_n$ on the rating plate of the motor.
P1.5	Motor Cos Phi	0.30	1.00		0.80	120	Find this value on the rating plate of the motor
P1.6	Motor nominal power	Varies	Varies	kW	Varies	116	Find this value $P_n$ on the rating plate of the motor.
P1.7	Motor current limit	Varies	Varies	A	Varies	107	Maximum motor current from AC drive
P1.8	Minimum frequency	0.00	P3.3.1	Hz	Varies	101	Minimum allowed frequency reference
P1.9	Maximum frequency	P3.3.1	320.00	Hz	50.00	102	Maximum allowed frequency reference
P1.10	I/O control reference A selection	1	8		7	117	Selection of ref source when control place is I/O A. See page 45 for selections.
P1.11	Preset frequency 1	P3.3.1	300.00	Hz	10.00	105	Select with digital input: Preset frequency selection 0 (P3.5.1.15)
P1.12	Preset frequency 2	P3.3.1	300.00	Hz	15.00	106	Select with digital input: Preset frequency selection 1 (P3.5.1.16)
P1.13	Acceleration time 1	0.1	3000.0	s	20.0	103	Time to accelerate from zero to maximum frequency
P1.14	Deceleration time 1	0.1	3000.0	s	20.0	104	Time to decelerate from minimum to zero frequency
P1.15	Remote control place	1	2		1	172	Selection of remote control place (start/stop) 1 = I/O 2 = Fieldbus
P1.16	Automatic reset	0	1		0	731	0 = Disabled 1 = Enabled
P1.17	PID Mini-Wizard	0	1		0	1803	0 = Inactive 1 = Activate See chapter 1.2.

P1.18	Multi-Pump Wizard	0	1		0		0 = Inactive 1 = Activate See chapter 1.3.
P1.19	Startup Wizard	0	1		0	1171	0 = Inactive 1 = Activate See chapter 1.1.

*Table 15. Quick setup parameter group*

### 3.4 MONITOR GROUP

Vacon 100 AC drive provides you with a possibility to monitor the actual values of parameters and signals as well as statuses and measurements. Some of the values to be monitored are customizable.

#### 3.4.1 MULTIMONITOR

On the multi-monitor page, you can collect nine values that you wish to monitor. See page 11 for more information.

#### 3.4.2 BASIC

See Table 16 in which the basic monitoring values are presented.

**NOTE!**

Only Standard I/O board statuses are available in the Monitor menu. Statuses for all I/O board signals can be found as raw data in the I/O and Hardware system menu.

Check expander I/O board statuses when required in the I/O and Hardware system menu.

Code	Monitoring value	Unit	ID	Description
V2.2.1	Output frequency	Hz	1	Output frequency to motor
V2.2.2	Frequency reference	Hz	25	Frequency reference to motor control
V2.2.3	Motor speed	rpm	2	Motor speed in rpm
V2.2.4	Motor current	A	3	
V2.2.5	Motor torque	%	4	Calculated shaft torque
V2.2.7	Motor shaft power	%	5	Total power consumption of AC drive
V2.2.8	Motor shaft power	kW/hp	73	
V2.2.9	Motor voltage	V	6	
V2.2.10	DC link voltage	V	7	
V2.2.11	Unit temperature	°C	8	Heatsink temperature
V2.2.12	Motor temperature	%	9	Calculated motor temperature
V2.2.13	Analogue input 1	%	59	Signal in percent of used range
V2.2.14	Analogue input 2	%	60	Signal in percent of used range
V2.2.15	Analogue output 1	%	81	Signal in percent of used range
V2.2.16	Motor Preheat		1228	0 = OFF 1 = Heating (feeding DC-current)
V2.2.17	Drive Status Word		43	Bit coded status of drive B1=Ready B2=Run B3=Fault B6=RunEnable B7=AlarmActive B10=DC Current in stop B11=DC Brake Active B12=RunRequest B13=MotorRegulatorActive
V2.2.18	Last active fault		37	The fault code of latest activated fault that has not been reset.

Code	Monitoring value	Unit	ID	Description
V2.2.19	Fire mode status		1597	0=Disabled 1=Enabled 2=Activated (Enabled + DI open) 3=Test mode
V2.2.20	DIN Status Word 1		56	16-bit word where each bit represents the status of one digital input. 6 digital inputs at every slot are read. Word 1 starts from input 1 in slot A (bit0) and goes to input 4 in slot C (bit15).
V2.2.21	DIN Status Word 2		57	16-bit word where each bit represents the status of one digital input. 6 digital inputs at every slot are read. Word 2 starts from input 5 in slot C (bit0) and goes to input 6 in slot E (bit13).
V2.2.22	Motor current with 1 decimal		45	Motor current monitor value with a fixed number of decimals and less filtering. Can be used e.g. for fieldbus purposes to always get the right value regardless of frame size, or monitoring when less filtering time is needed for the motor current.

Table 16. Monitoring menu items

### 3.4.3 TIMER FUNCTIONS MONITORING

Here you can monitor values of timer functions and the Real Time Clock.

Code	Monitoring value	Unit	ID	Description
V2.3.1	TC 1, TC 2, TC 3		1441	Possible to monitor the statuses of the three Time Channels (TC)
V2.3.2	Interval 1		1442	Status of timer interval
V2.3.3	Interval 2		1443	Status of timer interval
V2.3.4	Interval 3		1444	Status of timer interval
V2.3.5	Interval 4		1445	Status of timer interval
V2.3.6	Interval 5		1446	Status of timer interval
V2.3.7	Timer 1	s	1447	Remaining time on timer if active
V2.3.8	Timer 2	s	1448	Remaining time on timer if active
V2.3.9	Timer 3	s	1449	Remaining time on timer if active
V2.3.10	Real time clock		1450	

Table 17. Monitoring of timer functions

**3.4.4 PID1 CONTROLLER MONITORING**

Code	Monitoring value	Unit	ID	Description
V2.4.1	PID1 setpoint	Varies	20	Process units selected with parameter
V2.4.2	PID1 feedback	Varies	21	Process units selected with parameter
V2.4.3	PID1 error value	Varies	22	Process units selected with parameter
V2.4.4	PID1 output	%	23	Output to motor control or external control (AO)
V2.4.5	PID1 status		24	0=Stopped 1=Running 3=Sleep mode 4=In dead band (see page 67)

Table 18. PID1-controller value monitoring

**3.4.5 PID2 CONTROLLER MONITORING**

Code	Monitoring value	Unit	ID	Description
V2.5.1	PID2 setpoint	Varies	83	Process units selected with parameter
V2.5.2	PID2 feedback	Varies	84	Process units selected with parameter
V2.5.3	PID2 error value	Varies	85	Process units selected with parameter
V2.5.4	PID2 output	%	86	Output to external control (AO)
V2.5.5	PID2 status		87	0=Stopped 1=Running 2=In dead band (see page 67)

Table 19. PID2-controller value monitoring

**3.4.6 MULTI-PUMP MONITORING**

Code	Monitoring value	Unit	ID	Description
V2.6.1	Motors running		30	The number of motors running when Multi-Pump function is used.
V2.6.2	Autochange		1114	Informs the user if autochange is requested.

Table 20. Multi-pump monitoring

3.4.7 FIELDBUS DATA MONITORING

Code	Monitoring value	Unit	ID	Description
V2.8.1	FB Control Word		874	Fieldbus control word used by application in bypass mode/format. Depending on the fieldbus type or profile the data can be modified before sent to application.
V2.8.2	FB speed reference		875	Speed reference scaled between minimum and maximum frequency at the moment it was received by the application. Minimum and maximum frequencies can be changed after the reference was received without affecting the reference.
V2.8.3	FB data in 1		876	Raw value of process data in 32-bit signed format
V2.8.4	FB data in 2		877	Raw value of process data in 32-bit signed format
V2.8.5	FB data in 3		878	Raw value of process data in 32-bit signed format
V2.8.6	FB data in 4		879	Raw value of process data in 32-bit signed format
V2.8.7	FB data in 5		880	Raw value of process data in 32-bit signed format
V2.8.8	FB data in 6		881	Raw value of process data in 32-bit signed format
V2.8.9	FB data in 7		882	Raw value of process data in 32-bit signed format
V2.8.10	FB data in 8		883	Raw value of process data in 32-bit signed format
V2.8.11	FB Status Word		864	Fieldbus status word sent by application in bypass mode/format. Depending on the FB type or profile the data can be modified before sent to the FB.
V2.8.12	FB speed actual		865	Actual speed in %. 0 and 100% correspond to minimum and maximum frequencies respectively. This is continuously updated depending on the momentary min and max frequencies and the output frequency.
V2.8.13	FB data out 1		866	Raw value of process data in 32-bit signed format
V2.8.14	FB data out 2		867	Raw value of process data in 32-bit signed format
V2.8.15	FB data out 3		868	Raw value of process data in 32-bit signed format
V2.8.16	FB data out 4		869	Raw value of process data in 32-bit signed format
V2.8.17	FB data out 5		870	Raw value of process data in 32-bit signed format
V2.8.18	FB data out 6		871	Raw value of process data in 32-bit signed format
V2.8.19	FB data out 7		872	Raw value of process data in 32-bit signed format
V2.8.20	FB data out 8		873	Raw value of process data in 32-bit signed format

Table 21. Fieldbus data monitoring

### 3.5 VACON HVAC APPLICATION - APPLICATION PARAMETER LISTS

Find the parameter menu and the parameter groups as guided below.

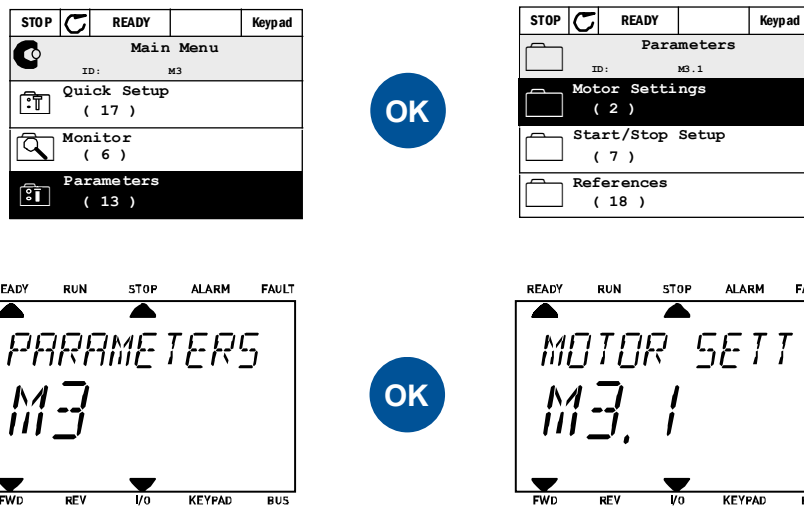

The HVAC Application embodies the following parameter groups:

Menu and Parameter group	Description
Group 3.1: Motor settings	Basic and advanced motor settings
Group 3.2: Start/Stop setup	Start and stop functions
Group 3.3: Control reference settings	Frequency reference setup
Group 3.4: Ramp & Brakes Setup	Acceleration/Deceleration setup
Group 3.5: I/O Configuration	I/O programming
Group 3.6: Fieldbus Data Mapping	Fieldbus data out parameters
Group 3.7: Prohibit Frequencies	Prohibit frequencies programming
Group 3.8: Limit supervisions	Programmable limit controllers
Group 3.9: Protections	Protections configuration
Group 3.10: Automatic reset	Auto reset after fault configuration
Group 3.11: Timer functions	Configuration of 3 timers based on Real Time Clock.
Group 3.12: PID-controller 1	Parameters for PID Controller 1. Motor control or external usage.
Group 3.13: PID-controller 2	Parameters for PID Controller 2. External usage.
Group 3.14: Multi-pump	Parameters for multi-pump usage.
Group 3.16: Fire mode	Parameters for Fire Mode.

Table 22. Parameter groups

**3.5.1 COLUMN EXPLANATIONS**

Code	=	Location indication on the keypad; Shows the operator the parameter number.
Parameter	=	Name of parameter
Min	=	Minimum value of parameter
Max	=	Maximum value of parameter
Unit	=	Unit of parameter value; Given if available
Default	=	Value preset by factory
ID	=	ID number of the parameter
Description	=	Short description of parameter values or its function
	=	More information on this parameter available; Click the parameter name

### 3.5.2 PARAMETER PROGRAMMING

The programming of digital inputs in Vacon HVAC Application is very flexible. There are no digital terminals assigned only for certain function. You can choose the terminal of your choice for the certain function, in other words, functions appear as parameters which the operator defines a certain input for. For a list of functions for the digital inputs, see Table 29 on page 47.

Also *Time Channels* can be assigned to digital inputs. See more information on page 63.

The selectable values of the programmable parameters are of type

**DigIN SlotA.1** (graphical keypad) or

**dl A.1** (text keypad)

in which

'**DigIN / dl**' stand for digital input.

'**Slot\_**' refers to the board;

**A** and **B** are Vacon AC drive standard boards, **D** and **E** are option boards (see Figure 13). See chapter 3.5.2.3.

**The number** after the board letter refers to the respective terminal on the selected board.

Hence, **SlotA.1 / A.1** means terminal DIN1 on the standard board in board slot A. The parameter (signal) is not connected to any terminal, i.e. it is not used, if, instead of a letter, the final number is preceded by a '**0**' (for example **DigIN Slot0.1 / dl 0.1**).

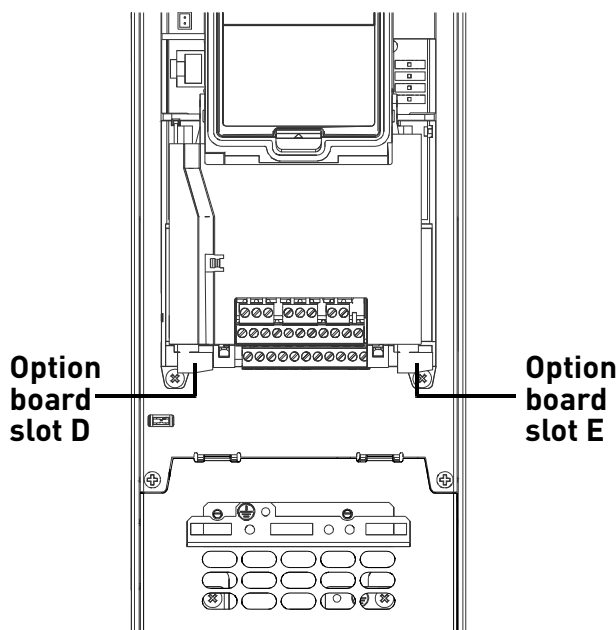

Figure 13. Option board slots

**EXAMPLE:**

You want to connect the *Control signal 2 A* (parameter P3.5.1.2) to digital input DI2 on Standard I/O board.

3.5.2.1 Example programming with graphical keypad

**1** Locate the parameter *Control signal 2 A* (P3.5.1.2) on the keypad.

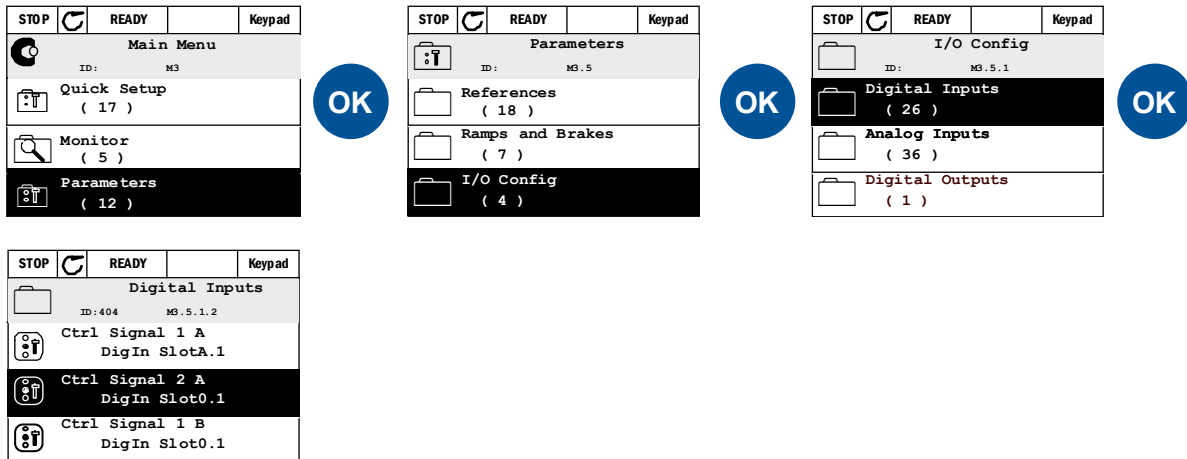

**2** Enter the *Edit* mode.

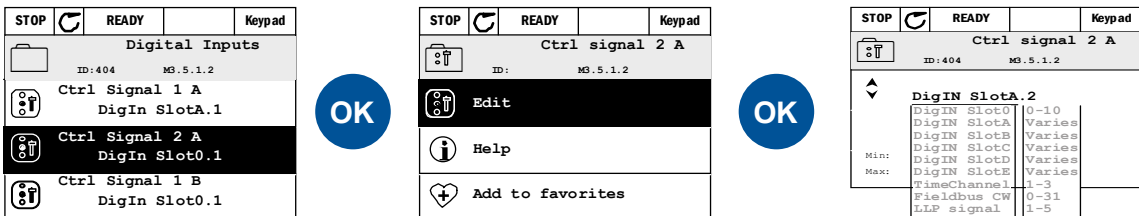

**3** **Change the value:** The editable part of the value (DigIN Slot0) is underlined and blinking. Change the slot to DigIN SlotA or assign the signal to Time Channel with the arrow keys up and down. Make the terminal value (.1) editable by pressing the right key once and change the value to '2' with arrow keys up and down. Accept the change with OK button or return to previous menu level with BACK/RESET button.

3.5.2.2 Example programming with text keypad

**1** Locate the parameter Control signal 2 A (P3.5.1.2) on the keypad.

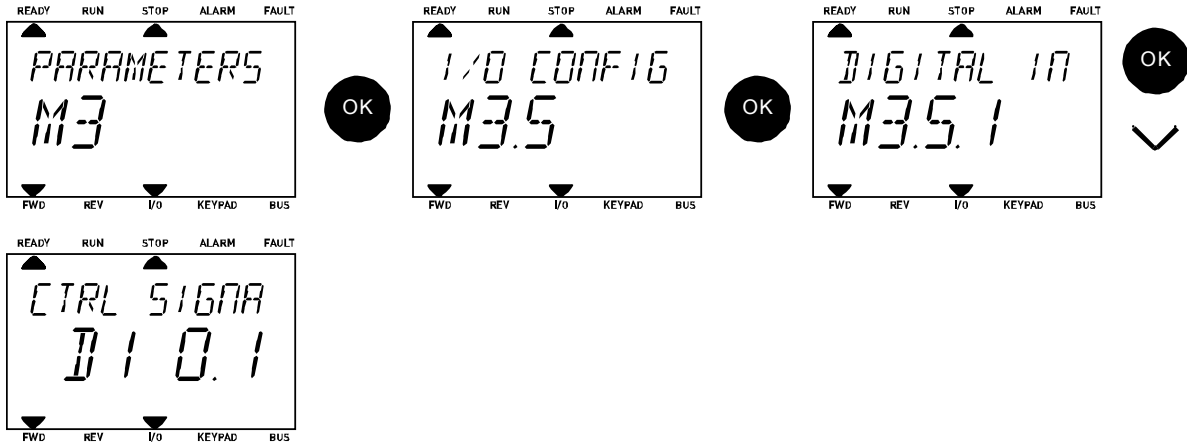

**2** Enter the Edit mode by pressing OK. The initial character starts to blink. Change the value of signal source to 'A' with the arrow buttons. Then press the arrow button right. Now the terminal number blinks. Connect the parameter Control signal 2 A (P3.5.1.2) to terminal DI2 by setting the terminal number to '2'.



### 3.5.2.3 *Descriptions of signal sources:*

Source	Function
Slot0	1 = Always FALSE, 2-9 = Always TRUE
SlotA	Number corresponds to digital input in the slot.
SlotB	Number corresponds to digital input in the slot.
SlotC	Number corresponds to digital input in the slot.
SlotD	Number corresponds to digital input in the slot.
SlotE	Number corresponds to digital input in the slot.
TimeChannel (tCh)	1=Time Channel1, 2=Time Channel2, 3=Time Channel3

Table 23. *Descriptions of signal sources*

3.5.3 GROUP 3.1: MOTOR SETTINGS

3.5.3.1 *Basic Settings*

Code	Parameter	Min	Max	Unit	Default	ID	Description
P3.1.1.1	Motor nominal voltage	Varies	Varies	V	Varies	110	Find this value $U_n$ on the rating plate of the motor. This parameter sets the voltage at the field weakening point to $100\% * U_{nMotor}$ . Note also used connection (Delta/Star).
P3.1.1.2	Motor nominal frequency	8.00	320.00	Hz	Varies	111	Find this value $f_n$ on the rating plate of the motor.
P3.1.1.3	Motor nominal speed	24	19200	rpm	Varies	112	Find this value $n_n$ on the rating plate of the motor.
P3.1.1.4	Motor nominal current	Varies	Varies	A	Varies	113	Find this value $I_n$ on the rating plate of the motor.
P3.1.1.5	Motor Cos Phi	0.30	1.00		0.80	120	Find this value on the rating plate of the motor
P3.1.1.6	Motor nominal power	Varies	Varies	kW	Varies	116	Find this value $P_n$ on the rating plate of the motor.
P3.1.1.7	Motor current limit	Varies	Varies	A	Varies	107	Maximum motor current from AC drive

Table 24. Basic motor settings



3.5.3.2 *Motor Control Settings*

Code	Parameter	Min	Max	Unit	Default	ID	Description
P3.1.2.1	Switching frequency	1.5	Varies	kHz	Varies	601	Motor noise can be minimized using a high switching frequency. Increasing the switching frequency reduces the capacity of the drive. It is recommended to use a lower frequency when the motor cable is long in order to minimize capacitive currents in the cable.
P3.1.2.2	Motor switch	0	1		0	653	Enabling this function prevents the drive from tripping when the motor switch is closed and opened e.g. using flying start. 0 = Disabled 1 = Enabled
P3.1.2.4	Zero frequency voltage	0.00	40.00	%	Varies	606	This parameter defines the zero frequency voltage of the U/f curve. The default value varies according to unit size.
P3.1.2.5	Motor preheat function	0	3		0	1225	0 = Not used 1 = Always in stop state 2 = Controlled by DI 3 = Temp limit (heatsink) <b>NOTE:</b> Virtual digital input can be activated by Real Time Clock
P3.1.2.6	Motor preheat temperature limit	-20	80	°C	0	1226	Motor preheat is switched on when the heatsink temperature goes below this level (if par. P3.1.2.5 is set to <b>Temperature limit</b> ). If limit is e.g. 10°C feeding current starts at 10 °C and stops at 11°C (1-degree hysteresis).
P3.1.2.7	Motor preheat current	0	0.5*I <sub>L</sub>	A	Varies	1227	DC current for pre-heating of motor and drive in stop state. Activated by digital input or by temperature limit.
P3.1.2.9	U/f ratio selection	0	1		Varies	108	Type of U/f curve between zero frequency and the field weakening point. 0 = Linear 1 = Squared
P3.1.2.15	Overvoltage controller	0	1		1	607	0 = Disabled 1 = Enabled
P3.1.2.16	Undervoltage controller	0	1		1	608	0 = Disabled 1 = Enabled



P3.1.2.18	Energy optimization	0	1		0	666	The drive searches for the minimum motor current in order to save energy and to lower the motor noise. This function can be used e.g. in fan and pump applications 0 = Disabled 1 = Enabled
-----------	---------------------	---	---	--	---	-----	---------------------------------------------------------------------------------------------------------------------------------------------------------------------------------------------------

*Table 25. Advanced motor settings*

**3.5.4 GROUP 3.2: START/STOP SETUP**

Start/Stop commands are given differently depending on the control place.

**Remote control place (I/O A):** Start, stop and reverse commands are controlled by 2 digital inputs chosen with parameters P3.5.1.1 and P3.5.1.2. The functionality/logic for these inputs is then selected with parameter P3.2.6 (in this group).

**Remote control place (I/O B):** Start, stop and reverse commands are controlled by 2 digital inputs chosen with parameters P3.5.1.3 and P3.5.1.4. The functionality/logic for these inputs is then selected with parameter P3.2.7 (in this group).

**Local control place (Keypad):** Start and stop commands come from the keypad buttons, while the direction of rotation is selected by the parameter P3.3.7.

**Remote control place (Fieldbus):** Start, stop and reverse commands come from fieldbus.

Code	Parameter	Min	Max	Unit	Default	ID	Description
P3.2.1	Remote control place	0	1		0	172	Selection of remote control place (start/stop). Can be used to change back to remote control from Vacon Live e.g. in case of a broken panel. 0=I/O control 1=Fieldbus control
P3.2.2	Local/Remote	0	1		0	211	Switch between local and remote control places 0=Remote 1=Local
P3.2.3	Keypad stop button	0	1		0	114	0=Stop button always enabled (Yes) 1=Limited function of Stop button (No)
P3.2.4	Start function	0	1		Varies	505	0=Ramping 1=Flying start
P3.2.5	Stop function	0	1		0	506	0=Coasting 1=Ramping
P3.2.6	I/O A start/stop logic	0	4		0	300	<b>Logic = 0:</b> Ctrl sgn 1 = Forward Ctrl sgn 2 = Backward <b>Logic = 1:</b> Ctrl sgn 1 = Forward (edge) Ctrl sgn 2 = Inverted Stop <b>Logic = 2:</b> Ctrl sgn 1 = Forward (edge) Ctrl sgn 2 = Bckwrd (edge) <b>Logic = 3:</b> Ctrl sgn 1 = Start Ctrl sgn 2 = Reverse <b>Logic = 4:</b> Ctrl sgn 1 = Start (edge) Ctrl sgn 2 = Reverse
P3.2.7	I/O B start/stop logic	0	4		0	363	See above.
P3.2.8	Fieldbus start logic	0	1		0	889	0=Rising edge required 1=State

Table 26. Start/Stop Setup menu

**3.5.5 GROUP 3.3: CONTROL REFERENCE SETTINGS**

The frequency reference source is programmable for all control places except *PC*, which always takes the reference from the PC tool.









**Remote control place (I/O A):** The source of frequency reference can be selected with parameter P3.3.3.

**Remote control place (I/O B):** The source of frequency reference can be selected with parameter P3.3.4.

**Local control place (Keypad):** If the default selection for parameter P3.3.5 is used the reference set with parameter P3.3.6 applies.

**Remote control place (Fieldbus):** The frequency reference comes from fieldbus if the default value for parameter P3.3.9 is kept.

Code	Parameter	Min	Max	Unit	Default	ID	Description
P3.3.1	Minimum frequency	0.00	P3.3.2	Hz	0.00	101	Minimum allowed frequency reference
P3.3.2	Maximum frequency	P3.3.1	320.00	Hz	50.00	102	Maximum allowed frequency reference
P3.3.3	I/O control reference A selection	1	8		6	117	Selection of ref source when control place is I/O A 1 = Preset Frequency 0 2 = Keypad reference 3 = Fieldbus 4 = AI1 5 = AI2 6 = AI1+AI2 7 = PID 1 reference 8 = Motor potentiometer
P3.3.4	I/O control reference B selection	1	8		4	131	Selection of ref source when control place is I/O B. See above. <b>NOTE:</b> I/O B control place can only be forced active with digital input (P3.5.1.5).
P3.3.5	Keypad Ctrl Reference selection	1	8		2	121	Selection of ref source when control place is keypad: 1 = Preset Frequency 0 2 = Keypad 3 = Fieldbus 4 = AI1 5 = AI2 6 = AI1+AI2 7 = PID 1 reference 8 = Motor potentiometer
P3.3.6	Keypad reference	0.00	P3.3.2	Hz	0.00	184	The frequency reference can be adjusted on the keypad with this parameter.
P3.3.7	Keypad direction	0	1		0	123	Motor rotation when control place is keypad 0 = Forward 1 = Reverse

	P3.3.8	Keypad reference copy	0	2		1	181	Selects function for Run state & Reference copy when changing to Keypad control: 0 = Copy reference 1 = Copy ref & Run State 2 = No copying
	P3.3.9	Fieldbus control reference selection	1	8		3	122	Selection of ref source when control place is Fieldbus: 1 = Preset frequency 0 2 = Keypad 3 = Fieldbus 4 = AI1 5 = AI2 6 = AI1+AI2 7 = PID 1 reference 8 = Motor potentiometer
	P3.3.10	Preset frequency mode	0	1		0	182	0 = Binary coded 1 = Number of inputs. Preset frequency is selected according to how many of preset speed digital inputs are active
	P3.3.11	Preset frequency 0	P3.3.1	P3.3.2	Hz	5.00	180	Basic preset frequency 0 when selected by Control reference parameter (P3.3.3).
	P3.3.12	Preset frequency 1	P3.3.1	P3.3.2	Hz	10.00	105	Select with digital input: Preset frequency selection 0 (P3.5.1.15)
	P3.3.13	Preset frequency 2	P3.3.1	P3.3.2	Hz	15.00	106	Select with digital input: Preset frequency selection 1 (P3.5.1.16)
	P3.3.14	Preset frequency 3	P3.3.1	P3.3.2	Hz	20.00	126	Select with digital inputs: Preset frequency selection 0 & 1
	P3.3.15	Preset frequency 4	P3.3.1	P3.3.2	Hz	25.00	127	Select with digital input: Preset frequency selection 2 (P3.5.1.17)
	P3.3.16	Preset frequency 5	P3.3.1	P3.3.2	Hz	30.00	128	Select with digital inputs: Preset frequency selection 0 & 2
	P3.3.17	Preset frequency 6	P3.3.1	P3.3.2	Hz	40.00	129	Select with digital inputs: Preset frequency selection 1 & 2
	P3.3.18	Preset frequency 7	P3.3.1	P3.3.2	Hz	50.00	130	Select with digital inputs: Preset frequency selection 0 & 1 & 2
	P3.3.19	Preset alarm frequency	P3.3.1	P3.3.2	Hz	25.00	183	This frequency used when fault response (in Group 3.9: Protections) is Alarm+preset frequency
	P3.3.20	Motor potentiometer ramp time	0.1	500.0	Hz/s	10.0	331	Rate of change in the motor potentiometer reference when increased or decreased.

P3.3.21	Motor potentiometer reset	0	2		1	367	Motor potentiometer frequency reference reset logic. 0 = No reset 1 = Reset if stopped 2 = Reset if powered down
---------	---------------------------	---	---	--	---	-----	---------------------------------------------------------------------------------------------------------------------------

Table 27. Control reference settings

**3.5.6 GROUP 3.4: RAMP & BRAKES SETUP**

Two ramps are available (two sets of acceleration time, deceleration time and ramp shape). The second ramp can be activated by a digital input. **NOTE!** Ramp 2 always has higher priority and is used if a digital input for ramp selection is activated or Ramp 2 threshold is smaller than RampFreqOut.

Code	Parameter	Min	Max	Unit	Default	ID	Description
P3.4.1	Ramp 1 shape	0.0	10.0	s	0.0	500	S-curve time ramp 1
P3.4.2	Acceleration time 1	0.1	300.0	s	20.0	103	Defines the time required for the output frequency to increase from zero frequency to maximum frequency
P3.4.3	Deceleration time 1	0.1	300.0	s	20.0	104	Defines the time required for the output frequency to decrease from maximum frequency to zero frequency
P3.4.4	Ramp 2 shape	0.0	10.0	s	0.0	501	S-curve time ramp 2. See P3.4.1.
P3.4.5	Acceleration time 2	0.1	300.0	s	10.0	502	See P3.4.2.
P3.4.6	Deceleration time 2	0.1	300.0	s	10.0	503	See P3.4.3.
P3.4.7	Start magnetizing time	0,00	600,00	s	0,00	516	This parameter defines the time for how long DC current is fed to motor before acceleration starts.
P3.4.8	Start magnetizing current	Varies	Varies	A	Varies	517	
P3.4.9	DC braking time at stop	0,00	600,00	s	0,00	508	Determines if braking is ON or OFF and the braking time of the DC-brake when the motor is stopping.
P3.4.10	DC brake current	Varies	Varies	A	Varies	507	Defines the current injected into the motor during DC-braking. 0 = Disabled
P3.4.11	Frequency to start DC braking at ramp stop	0,10	10,00	Hz	1,50	515	The output frequency at which the DC-braking is applied.
P3.4.12	Flux braking	0	1		0	520	0=Disabled 1=Enabled
P3.4.13	Flux braking current	0	Varies	A	Varies	519	Defines the current level for flux braking.

Table 28. Ramp and brakes setup

### 3.5.7 GROUP 3.5: I/O CONFIGURATION

#### 3.5.7.1 Digital inputs

Digital inputs are very flexible to use. Parameters are functions that are connected to the required digital input terminal. The digital inputs are represented as, for example, *DigIN Slot A.2*, meaning the second input on slot A.

It is also possible to connect the digital inputs to time channels which are also represented as terminals.

**NOTE!** The statuses of digital inputs and the digital output can be monitored in the Multimonitoring view, see chapter 3.4.1.

Code	Parameter	Default	ID	Description
P3.5.1.1	Control signal 1 A	DigIN SlotA.1	403	Start signal 1 when control place is I/O 1 (FWD)
P3.5.1.2	Control signal 2 A	DigIN Slot0.1	404	Start signal 2 when control place is I/O 1 (REV)
P3.5.1.3	Control signal 1 B	DigIN Slot0.1	423	Start signal 1 when control place is I/O B
P3.5.1.4	Control signal 2 B	DigIN Slot0.1	424	Start signal 2 when control place is I/O B
P3.5.1.5	I/O B control force	DigIN Slot0.1	425	TRUE = Force the control place to I/O B
P3.5.1.6	I/O B reference force	DigIN Slot0.1	343	TRUE = Used frequency reference is specified by I/O reference B parameter (P3.3.4).
P3.5.1.7	External fault close	DigIN SlotA.3	405	FALSE = OK TRUE = External fault
P3.5.1.8	External fault open	DigIN Slot0.2	406	FALSE = External fault TRUE = OK
P3.5.1.9	Fault reset	DigIN SlotA.6	414	Resets all active faults
P3.5.1.10	Run enable	DigIN Slot0.2	407	Must be on to set drive in Ready state
P3.5.1.11	Run interlock 1	DigIN Slot0.1	1041	Drive may be ready but start is blocked as long as interlock is on (Damper interlock).
P3.5.1.12	Run interlock 2	DigIN Slot0.1	1042	As above.
P3.5.1.13	Motor preheat ON	DigIN Slot0.1	1044	FALSE = No action TRUE = Uses the motor preheat DC-Current in Stop state Used when parameter P3.1.2.5 is set to 2.
P3.5.1.14	Fire Mode activation	DigIN Slot0.2	1596	FALSE = Fire Mode active TRUE = No action
P3.5.1.15	Preset frequency selection 0	DigIN SlotA.4	419	Binary selector for Preset speeds (0-7). See page 46.
P3.5.1.16	Preset frequency selection 1	DigIN SlotA.5	420	Binary selector for Preset speeds (0-7). See page 46.
P3.5.1.17	Preset frequency selection 2	DigIN Slot0.1	421	Binary selector for Preset speeds (0-7). See page 46.
P3.5.1.18	Timer 1	DigIN Slot0.1	447	Rising edge starts Timer 1 programmed in Group 3.11: Timer functions parameter group
P3.5.1.19	Timer 2	DigIN Slot0.1	448	See above
P3.5.1.20	Timer 3	DigIN Slot0.1	449	See above
P3.5.1.21	PID1 setpoint boost	DigIN Slot0.1	1047	FALSE = No boost TRUE = Boost
P3.5.1.22	PID1 select setpoint	DigIN Slot0.1	1046	FALSE = Setpoint 1 TRUE = Setpoint 2

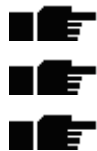

P3.5.1.23	PID2 start signal	DigIN Slot0.2	1049	FALSE = PID2 in stop mode TRUE = PID2 regulating This parameter will have no effect if PID2 controller is not enabled in the Basic menu for PID2
P3.5.1.24	PID2 select setpoint	DigIN Slot0.1	1048	FALSE = Setpoint 1 TRUE = Setpoint 2
P3.5.1.25	Motor 1 interlock	DigIN Slot0.1	426	FALSE = Not active TRUE = Active
P3.5.1.26	Motor 2 interlock	DigIN Slot0.1	427	FALSE = Not active TRUE = Active
P3.5.1.27	Motor 3 interlock	DigIN Slot0.1	428	FALSE = Not active TRUE = Active
P3.5.1.28	Motor 4 interlock	DigIN Slot0.1	429	FALSE = Not active TRUE = Active
P3.5.1.30	Motor potentiometer UP	DigIN Slot0.1	418	FALSE = Not active TRUE = Active (Motor potentiometer reference INCREASES until the contact is opened)
P3.5.1.31	Motor potentiometer DOWN	DigIN Slot0.1	417	FALSE = Not active TRUE = Active (Motor potentiometer reference DECREASES until the contact is opened)
P3.5.1.32	Ramp 2 selection	DigIN Slot0.1	408	Used for switching between ramp 1 and 2. OPEN = Ramp1 shape, acceleration time 1 and deceleration time 1. CLOSED = Ramp2 shape, acceleration time 2 and deceleration time 2.
P3.5.1.33	Fieldbus control	DigIN Slot0.1	441	TRUE = Forces control place to fieldbus.
P3.5.1.34	Fire mode reverse	DigIN Slot0.1	1618	Reverse command of rotation direction while running in Fire Mode. This function has no effect in normal operation. FALSE = Forward TRUE = Reverse

Table 29. Digital input settings

## 3.5.7.2 Analogue inputs

Code	Parameter	Min	Max	Unit	Default	ID	Description
P3.5.2.1	AI1 signal selection				AnIN SlotA.1	377	Connect the AI1 signal to the analogue input of your choice with this parameter. Programmable
P3.5.2.2	AI1 signal filter time	0.00	300.00	s	0.1	378	Filter time for analogue input
P3.5.2.3	AI1 signal range	0	1		0	379	0 = 0...10V / 0...20mA 1 = 2...10V / 4...20mA
P3.5.2.4	AI1 custom. min	-160.00	160.00	%	0.00	380	Custom range min setting 20% = 4-20 mA/2-10 V
P3.5.2.5	AI1 custom. max	-160.00	160.00	%	100.00	381	Custom range max setting
P3.5.2.6	AI1 signal inversion	0	1		0	387	0 = Normal 1 = Signal inverted
P3.5.2.7	AI2 signal selection				AnIN SlotA.2	388	See P3.5.2.1.
P3.5.2.8	AI2 signal filter time	0.00	300.00	s	0.1	389	See P3.5.2.2.
P3.5.2.9	AI2 signal range	0	1		1	390	0 = 0...10V / 0...20mA 1 = 2...10V / 4...20mA
P3.5.2.10	AI2 custom. min	-160.00	160.00	%	0.00	391	See P3.5.2.4.
P3.5.2.11	AI2 custom. max	-160.00	160.00	%	100.00	392	See P3.5.2.5.
P3.5.2.12	AI2 signal inversion	0	1		0	398	See P3.5.2.6.
P3.5.2.13	AI3 signal selection				AnIN Slot0.1	141	Connect the AI3 signal to the analogue input of your choice with this parameter. Programmable
P3.5.2.14	AI3 signal filter time	0.00	300.00	s	0.1	142	Filter time for analogue input
P3.5.2.15	AI3 signal range	0	1		0	143	0 = 0...10V / 0...20mA 1 = 2...10V / 4...20mA
P3.5.2.16	AI3 custom. min	-160.00	160.00	%	0.00	144	20% = 4-20 mA/2-10 V
P3.5.2.17	AI3 custom. max	-160.00	160.00	%	100.00	145	Custom range max setting
P3.5.2.18	AI3 signal inversion	0	1		0	151	0 = Normal 1 = Signal inverted
P3.5.2.19	AI4 signal selection				AnIN Slot0.1	152	See P3.5.2.13. Programmable
P3.5.2.20	AI4 signal filter time	0.00	300.00	s	0.1	153	See P3.5.2.14.
P3.5.2.21	AI4 signal range	0	1		0	154	0 = 0...10V / 0...20mA 1 = 2...10V / 4...20mA
P3.5.2.22	AI4 custom. min	-160.00	160.00	%	0.00	155	See P3.5.2.16.
P3.5.2.23	AI4 custom. max	-160.00	160.00	%	100.00	156	See P3.5.2.17.
P3.5.2.24	AI4 signal inversion	0	1		0	162	See P3.5.2.18.
P3.5.2.25	AI5 signal selection				AnIN Slot0.1	188	Connect the AI5 signal to the analogue input of your choice with this parameter. Programmable.
P3.5.2.26	AI5 signal filter time	0.00	300.00	s	0.1	189	Filter time for analogue input
P3.5.2.27	AI5 signal range	0	1		0	190	0 = 0...10V / 0...20mA 1 = 2...10V / 4...20mA
P3.5.2.28	AI5 custom. min	-160.00	160.00	%	0.00	191	20% = 4-20 mA/2-10 V
P3.5.2.29	AI5 custom. max	-160.00	160.00	%	100.00	192	Custom range max setting

P3.5.2.30	AI5 signal inversion	0	1		0	198	0 = Normal 1 = Signal inverted
P3.5.2.31	AI6 signal selection				AnIN Slot0.1	199	See P3.5.2.13. Programmable
P3.5.2.32	AI6 signal filter time	0.00	300.00	s	0.1	200	See P3.5.2.14.
P3.5.2.33	AI6 signal range	0	1		0	201	0 = 0...10V / 0...20mA 1 = 2...10V / 4...20mA
P3.5.2.34	AI6 custom. min	-160.00	160.00	%	0.00	202	See P3.5.2.16.
P3.5.2.35	AI6 custom. max	-160.00	160.00	%	100.00	203	See P3.5.2.17.
P3.5.2.36	AI6 signal inversion	0	1		0	209	See P3.5.2.18.

Table 30. Analogue input settings

3.5.7.3 Digital outputs, slot B (Basic)

Code	Parameter	Min	Max	Unit	Default	ID	Description
P3.5.3.2.1	Basic R01 function	0	35		2	11001	Function selection for Basic R01: 0 = None 1 = Ready 2 = Run 3 = General fault 4 = General fault inverted 5 = General alarm 6 = Reversed 7 = At speed 8 = Motor regulator active 9 = Preset speed active 10 = Keypad control active 11 = I/O B control activated 12 = Limit supervision 1 13 = Limit supervision 2 14 = Start signal active 15 = Reserved 16 = Fire Mode activation 17 = RTC time chnl 1 control 18 = RTC time chnl 2 control 19 = RTC time chnl 3 control 20 = FB ControlWord B13 21 = FB ControlWord B14 22 = FB ControlWord B15 23 = PID1 in Sleep mode 24 = Reserved 25 = PID1 supervision limits 26 = PID2 supervision limits 27 = Motor 1 control 28 = Motor 2 control 29 = Motor 3 control 30 = Motor 4 control 31 = Reserved (Always open) 32 = Reserved (Always open) 33 = Reserved (Always open) 34 = Maintenance alarm 35 = Maintenance fault
P3.5.3.2.2	Basic R01 ON delay	0.00	320.00	s	0.00	11002	ON delay for relay
P3.5.3.2.3	Basic R01 OFF delay	0.00	320.00	s	0.00	11003	OFF delay for relay
P3.5.3.2.4	Basic R02 function	0	35		3	11004	See P3.5.3.2.1
P3.5.3.2.5	Basic R02 ON delay	0.00	320.00	s	0.00	11005	See P3.5.3.2.2.
P3.5.3.2.6	Basic R02 OFF delay	0.00	320.00	s	0.00	11006	See P3.5.3.2.3.
P3.5.3.2.7	Basic R03 function	0	35		1	11007	See P3.5.3.2.1. Not visible if only 2 output relays are installed

Table 31. Digital output settings on standard I/O board

3.5.7.4 Expander slots D and E digital outputs

Code	Parameter	Min	Max	Unit	Default	ID	Description
	Application dynamic output list						Shows only parameters for existing outputs in slot D/E. Selections as in Basic R01 Not visible if no digital output exists in slot D/E.

Table 32. Slot D/E digital outputs

3.5.7.5 Analogue outputs, Slot A (Standard)

Code	Parameter	Min	Max	Unit	Default	ID	Description
P3.5.4.1.1	A01 function	0	19		2	10050	0=TEST 0% (Not used) 1=TEST 100% 2=Output freq (0 -fmax) 3=Freq reference (0-fmax) 4=Motor speed (0 - Motor nominal speed) 5=Output current (0-I <sub>nMotor</sub> ) 6=Motor torque (0-T <sub>nMotor</sub> ) 7=Motor power (0-P <sub>nMotor</sub> ) 8=Motor voltage (0-U <sub>nMotor</sub> ) 9=DC link voltage (0-1000V) 10=PID1 output (0-100%) 11=PID2 output (0-100%) 12=ProcessDataIn1 13=ProcessDataIn2 14=ProcessDataIn3 15=ProcessDataIn4 16=ProcessDataIn5 17=ProcessDataIn6 18=ProcessDataIn7 19=ProcessDataIn8 <b>NOTE:</b> For ProcessDataIn, e.g. value 5000 = 50.00%
P3.5.4.1.2	A01 filter time	0.00	300.00	s	1.00	10051	Filtering time of analogue output signal. See P3.5.2.2 0 = No filtering
P3.5.4.1.3	A01 minimum	0	1		0	10052	0 = 0 mA / 0V 1 = 4 mA / 2V Note the difference in analogue output scaling in parameter P3.5.4.1.4.
P3.5.4.1.4	A01 minimum scale	Varies	Varies	Varies	0.0	10053	Min scale in process unit (depends on selection of A01 function)
P3.5.4.1.5	A01 maximum scale	Varies	Varies	Varies	0.0	10054	Max scale in process unit (depends on selection of A01 function)

Table 33. Standard I/O board analogue output settings

### 3.5.7.6 Expander slots D to E analogue outputs

Code	Parameter	Min	Max	Unit	Default	ID	Description
	Application dynamic output list						Shows only parameters for existing outputs in slot D/E. Selections as in Basic A01 Not visible if no analogue output exists in slot D/E.

Table 34. Slot D/E analogue outputs

**3.5.8 GROUP 3.6: FIELDBUS DATA MAPPING**

Code	Parameter	Min	Max	Unit	Default	ID	Description
P3.6.1	Fieldbus data out 1 selection	0	35000		1	852	Data sent to fieldbus can be chosen with parameter and monitor value ID numbers. The data is scaled to unsigned 16-bit format according to the format on keypad. E.g. 25.5 on keypad equals 255.
P3.6.2	Fieldbus data out 2 selection	0	35000		2	853	Select Process Data Out with parameter ID
P3.6.3	Fieldbus data out 3 selection	0	35000		3	854	Select Process Data Out with parameter ID
P3.6.4	Fieldbus data out 4 selection	0	35000		45	855	Select Process Data Out with parameter ID
P3.6.5	Fieldbus data out 5 selection	0	35000		5	856	Select Process Data Out with parameter ID
P3.6.6	Fieldbus data out 6 selection	0	35000		6	857	Select Process Data Out with parameter ID
P3.6.7	Fieldbus data out 7 selection	0	35000		7	858	Select Process Data Out with parameter ID
P3.6.8	Fieldbus data out 8 selection	0	35000		37	859	Select Process Data Out with parameter ID

*Table 35. Fieldbus data mapping*

**Fieldbus process data out**

Values to monitor through fieldbus are:

Data	Value	Scale
Process Data Out 1	Output frequency	0.01 Hz
Process Data Out 2	Motor speed	1 rpm
Process Data Out 3	Motor current	0.1 A
Process Data Out 4	Motor torque	0.1 %
Process Data Out 5	Motor power	0.1 %
Process Data Out 6	Motor voltage	0.1 V
Process Data Out 7	DC-link voltage	1 V
Process Data Out 8	Last active fault code	

*Table 36. Fieldbus Process Data Out*

### 3.5.9 GROUP 3.7: PROHIBIT FREQUENCIES

In some systems it may be necessary to avoid certain frequencies due to mechanical resonance problems. By setting up prohibit frequencies it is possible to skip these ranges.

Code	Parameter	Min	Max	Unit	Default	ID	Description
P3.7.1	Prohibit frequency range 1 low limit	-1,00	320,00	Hz	0,00	509	0 = Not used
P3.7.2	Prohibit frequency range 1 high limit	0,00	320,00	Hz	0,00	510	0 = Not used
P3.7.3	Prohibit frequency range 2 low limit	0,00	320,00	Hz	0,00	511	0 = Not used
P3.7.4	Prohibit frequency range 2 high limit	0,00	320,00	Hz	0,00	512	0 = Not used
P3.7.5	Prohibit frequency range 3 low limit	0,00	320,00	Hz	0,00	513	0 = Not used
P3.7.6	Prohibit frequency range 3 high limit	0,00	320,00	Hz	0,00	514	0 = Not used
P3.7.7	Ramp time factor	0,1	10,0	Times	1,0	518	Multiplier of the currently selected ramp time between prohibit frequency limits.

*Table 37. Prohibit frequencies*

**3.5.10 GROUP 3.8: LIMIT SUPERVISIONS**

Choose here:

1. One or two (P3.8.1/P3.8.5) signal values for supervision.
2. Whether the low or high limits are supervised (P3.8.2/P3.8.6)
3. The actual limit values (P3.8.3/P3.8.7).
4. The hystereses for the set limit values (P3.8.4/P3.8.8).

Code	Parameter	Min	Max	Unit	Default	ID	Description
P3.8.1	Supervision #1 item selection	0	7		0	1431	0 = Output frequency 1 = Frequency reference 2 = Motor current 3 = Motor torque 4 = Motor power 5 = DC-link voltage 6 = Analogue input 1 7 = Analogue input 2
P3.8.2	Supervision #1 mode	0	2		0	1432	0 = Not used 1 = Low limit supervision (output active over limit) 2 = High limit supervision (output active under limit)
P3.8.3	Supervision #1 limit	-200.000	200.000	Varies	25.00	1433	Supervision limit for selected item. Unit appears automatically.
P3.8.4	Supervision #1 limit hysteresis	-200.000	200.000	Varies	5.00	1434	Supervision limit hysteresis for selected item. Unit is set automatically.
P3.8.5	Supervision #2 item selection	0	7		1	1435	See P3.8.1
P3.8.6	Supervision #2 mode	0	2		0	1436	See P3.8.2
P3.8.7	Supervision #2 limit	-200.000	200.000	Varies	40.00	1437	See P3.8.3
P3.8.8	Supervision #2 limit hysteresis	-200.000	200.000	Varies	5.00	1438	See P3.8.4

*Table 38. Limits supervision settings*

**3.5.11 GROUP 3.9: PROTECTIONS**



**Parameters of Motor thermal protection (P3.9.6 to P3.9.10)**

The motor thermal protection is to protect the motor from overheating. The drive is capable of supplying higher than nominal current to the motor. If the load requires this high current there is a risk that the motor will be thermally overloaded. This is the case especially at low frequencies. At low frequencies the cooling effect of the motor is reduced as well as its capacity. If the motor is equipped with an external fan the load reduction at low speeds is small.

The motor thermal protection is based on a calculated model and it uses the output current of the drive to determine the load on the motor.

The motor thermal protection can be adjusted with parameters. The thermal current  $I_T$  specifies the load current above which the motor is overloaded. This current limit is a function of the output frequency.

The thermal stage of the motor can be monitored on the control keypad display. See chapter 3.4.

	<p>If you use long motor cables (max. 100m) together with small drives (<math>\leq 1.5</math> kW) the motor current measured by the drive can be much higher than the actual motor current due to capacitive currents in the motor cable. Consider this when setting up the motor thermal protection functions.</p>
	<p>The calculated model does not protect the motor if the airflow to the motor is reduced by blocked air intake grill. The model starts from zero if the control board is powered off.</p>

**Parameters of Stall protection (P3.9.11 to P3.9.14)**

The motor stall protection protects the motor from short time overload situations such as one caused by a stalled shaft. The reaction time of the stall protection can be set shorter than that of motor thermal protection. The stall state is defined with two parameters, P3.9.12 (*Stall current*) and P3.9.14 (*Stall frequency limit*). If the current is higher than the set limit and the output frequency is lower than the set limit the stall state is true. There is actually no real indication of the shaft rotation. Stall protection is a type of overcurrent protection.

	<p>If you use long motor cables (max. 100m) together with small drives (<math>\leq 1.5</math> kW) the motor current measured by the drive can be much higher than the actual motor current due to capacitive currents in the motor cable. Consider this when setting up the motor thermal protection functions.</p>
-------------------------------------------------------------------------------------	---------------------------------------------------------------------------------------------------------------------------------------------------------------------------------------------------------------------------------------------------------------------------------------------------------------------

**Parameters of Underload protection (P3.9.15 to P3.9.18)**

The purpose of the motor underload protection is to ensure that there is load on the motor when the drive is running. If the motor loses its load there might be a problem in the process, e.g. a broken belt or a dry pump.

Motor underload protection can be adjusted by setting the underload curve with parameters P3.9.16 (Underload protection: Field weakening area load) and P3.9.17 (*Underload protection: Zero frequency load*), see below. The underload curve is a squared curve set between the zero frequency and the field weakening point. The protection is not active below 5Hz (the underload time counter is stopped).

The torque values for setting the underload curve are set in percentage which refers to the nominal torque of the motor. The motor's name plate data, parameter motor nominal current and the drive's nominal current  $I_L$  are used to find the scaling ratio for the internal torque value. If other than nominal motor is used with the drive, the accuracy of the torque calculation decreases.

	<p>If you use long motor cables (max. 100m) together with small drives (<math>\leq 1.5</math> kW) the motor current measured by the drive can be much higher than the actual motor current due to capacitive currents in the motor cable. Consider this when setting up the motor thermal protection functions.</p>
-----------------------------------------------------------------------------------	---------------------------------------------------------------------------------------------------------------------------------------------------------------------------------------------------------------------------------------------------------------------------------------------------------------------

Code	Parameter	Min	Max	Unit	Default	ID	Description
P3.9.1	Response to Analogue input low fault	0	4		0	700	0=No action 1=Alarm 2=Alarm, set preset fault frequency (par. P3.3.19) 3=Fault (Stop according to stop mode) 4=Fault (Stop by coasting)
P3.9.2	Response to external fault	0	3		2	701	0 = No action 1 = Alarm 2 = Fault (Stop according to stop mode) 3 = Fault (Stop by coasting)
P3.9.3	Response to Input phase fault	0	3		3	730	See above
P3.9.4	Undervoltage fault	0	1		0	727	0 = Fault stored in history 1 = Fault not stored in history
P3.9.5	Response to output phase fault	0	3		2	702	See P3.9.2
P3.9.6	Motor thermal protection	0	3		2	704	See P3.9.2
P3.9.7	Motor ambient temperature factor	-20.0	100.0	°C	40.0	705	Ambient temperature in °C
P3.9.8	Motor thermal zero speed cooling	5.0	150.0	%	60.0	706	Defines the cooling factor at zero speed in relation to the point where the motor is running at nominal speed without external cooling.
P3.9.9	Motor thermal time constant	1	200	min	Varies	707	The time constant is the time within which the calculated thermal stage has reached 63% of its final value.
P3.9.10	Motor thermal loadability	0	150	%	100	708	
P3.9.11	Motor stall fault	0	3		0	709	See P3.9.2
P3.9.12	Stall current	0.00	$2 \cdot I_H$	A	$I_H$	710	For a stall stage to occur, the current must have exceeded this limit.
P3.9.13	Stall time limit	1.00	120.00	s	15.00	711	This is the maximum time allowed for a stall stage.

P3.9.14	Stall frequency limit	1.00	P3.3.2	Hz	25.00	712	For a stall state to occur, the output frequency must have remained below this limit for a certain time.
P3.9.15	Underload fault (broken belt/dry pump)	0	3		0	713	See P3.9.2
P3.9.16	Underload protection: Field weakening area load	10.0	150.0	%	50.0	714	This parameter gives the value for the minimum torque allowed when the output frequency is above the field weakening point.
P3.9.17	Underload protection: Zero frequency load	5.0	150.0	%	10.0	715	This parameter gives value for the minimum torque allowed with zero frequency. If you change the value of parameter P3.1.1.4 this parameter is automatically restored to the default value.
P3.9.18	Underload protection: Time limit	2.00	600.00	s	20.00	716	This is the maximum time allowed for an underload state to exist.
P3.9.19	Response to Fieldbus communication fault	0	4		3	733	See P3.9.1
P3.9.20	Slot communication fault	0	3		2	734	See P3.9.2
P3.9.21	Thermistor fault	0	3		0	732	See P3.9.2
P3.9.22	Response to PID1 supervision fault	0	3		2	749	See P3.9.2
P3.9.23	Response to PID2 supervision fault	0	3		2	757	See P3.9.2

Table 39. Protections settings

3.5.12 GROUP 3.10: AUTOMATIC RESET

Code	Parameter	Min	Max	Unit	Default	ID	Description
P3.10.1	Automatic reset	0	1		0	731	0 = Disabled 1 = Enabled
P3.10.2	Restart function	0	1		1	719	The start mode for Automatic reset is selected with this parameter: 0 = Flying start 1 = According to par. P3.2.4
P3.10.3	Wait time	0,10	10000,0	s	0,50	717	Wait time before the first reset is executed.
P3.10.4	Trial time	0,00	10000,0	s	60,00	718	When the trial time has elapsed, and the fault is still active, the drive will trip to fault.
P3.10.5	Number of trials	1	10		4	759	NOTE: Total number of trials (irrespective of fault type)
P3.10.6	Autoreset: Undervoltage	0	1		1	720	Autoreset permitted? 0 = No 1 = Yes
P3.10.7	Autoreset: Overvoltage	0	1		1	721	Autoreset permitted? 0 = No 1 = Yes
P3.10.8	Autoreset: Overcurrent	0	1		1	722	Autoreset permitted? 0 = No 1 = Yes
P3.10.9	Autoreset: AI low	0	1		1	723	Autoreset permitted? 0 = No 1 = Yes
P3.10.10	Autoreset: Unit over-temperature	0	1		1	724	Autoreset permitted? 0 = No 1 = Yes
P3.10.11	Autoreset: Motor over-temperature	0	1		1	725	Autoreset permitted? 0 = No 1 = Yes
P3.10.12	Autoreset: External fault	0	1		0	726	Autoreset permitted? 0 = No 1 = Yes
P3.10.13	Autoreset: Underload fault	0	1		0	738	Autoreset permitted? 0 = No 1 = Yes

Table 40. Autoreset settings

### 3.5.13 GROUP 3.11: TIMER FUNCTIONS

The time functions (Time Channels) in the Vacon 100 give you the possibility to program functions to be controlled by the internal RTC (Real Time Clock). Practically every function that can be controlled by a digital input can also be controlled by a Time Channel. Instead of having an external PLC controlling a digital input you can program the "closed" and "opened" intervals of the input internally.

**NOTE!** The functions of this parameter group can be made the fullest advantage of only if the battery (option) has been installed and the Real Time Clock settings have been properly made during the Startup Wizard (see page 2 and page 3). **It is not recommended** to use these function without battery backup because the drive's time and date settings will be reset at every power down if no battery for the RTC is installed.

#### Time channels

The on/off logic for the *Time channels* is configured by assigning *Intervals* or/and *Timers* to them. One *Time channel* can be controlled by many *Intervals* or *Timers* by assigning as many of these as needed to the *Time channel*.

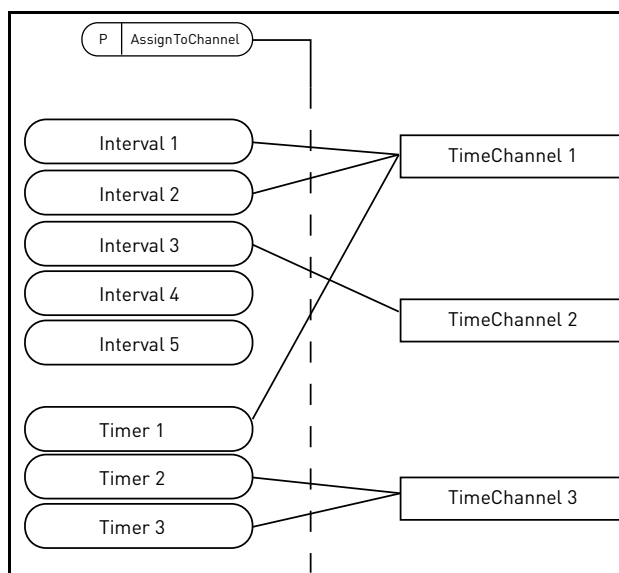

Figure 14. The intervals and timers can be assigned to time channels in a flexible way. Every interval and timer has its own parameter for assigning to a time channel.

#### Intervals

Every interval is given an "ON Time" and "OFF Time" with parameters. This is the daily time that the interval will be active during the days set with "From Day" and "To Day" parameters. E.g. the parameter setting below means that the interval is active from 7 am to 9 am every weekday (Monday to Friday). The Time Channel to which this Interval is assigned will be seen as a closed "virtual digital input" during that period.

**ON Time:** 07:00:00

**OFF Time:** 09:00:00

**From Day:** Monday

**To Day:** Friday

### Timers

Timers can be used to set a Time Channel active during a certain time by command from a digital input (or a Time Channel).

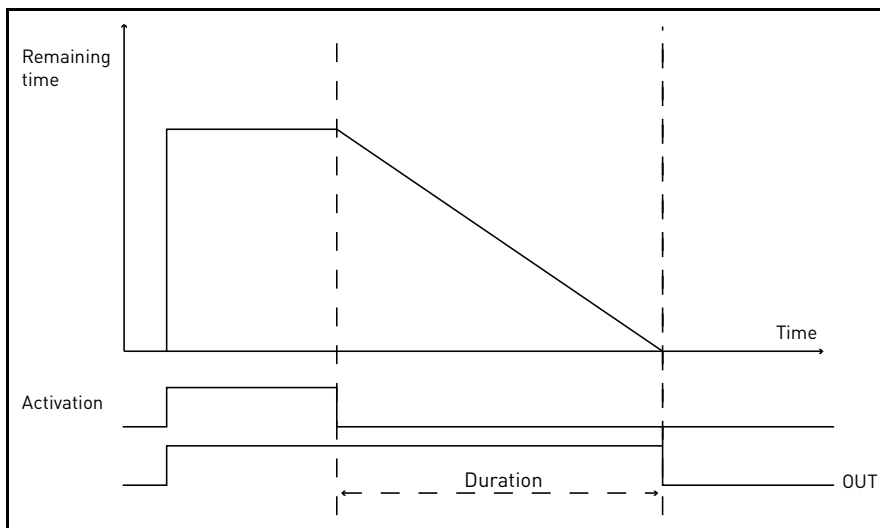

Figure 15. Activation signal comes from a digital input or "a virtual digital input" such as a Time channel. The Timer counts down from falling edge.

The below parameters will set the Timer active when Digital Input 1 on Slot A is closed and keep it active for 30s after it is opened.

**Duration:** 30s

**Timer:** DigiIn SlotA.1

**Tip:** A duration of 0 seconds can be used for simply overriding a Time channel activated from a digital input without any off delay after the falling edge.

### EXAMPLE

#### Problem:

We have a frequency converter for air conditioning in a warehouse. It needs to run between 7am - 5pm on weekdays and 9am - 1pm on weekends. Additionally, we need to be able to manually force the drive to run outside working hours if there are people in the building and to leave it running for 30 min afterwards.

#### Solution:

We need to set up two intervals, one for weekdays and one for weekends. A Timer is also needed for activation outside the office hours. An example of configuration below.

#### Interval 1:

P3.11.1.1: **ON Time: 07:00:00**

P3.11.1.2: **OFF Time: 17:00:00**

P3.11.1.3: **From Day: '1'** (=Monday)

P3.11.1.4: **To Day: '5'** (=Friday)

P3.11.1.5: **Assign to channel: Time channel 1**

#### Interval 2:

P3.11.2.1: **ON Time: 09:00:00**

P3.11.2.2: **OFF Time: 13:00:00**

P3.11.2.3: *From Day*: **Saturday**

P3.11.2.4: *To Day*: **Sunday**

P3.11.2.5: *AssignToChannel*: **Time channel 1**

**Timer 1**

The manual bypassing can be handled by a digital input 1 on slot A (by a different switch or connection to lighting).

P3.11.6.1: *Duration*: **1800s** (30min)

P3.11.6.2: *Assign to channel*: **Time channel 1**

P3.5.1.18: *Timer 1: DigIn SlotA.1* (Parameter located in digital inputs menu.)

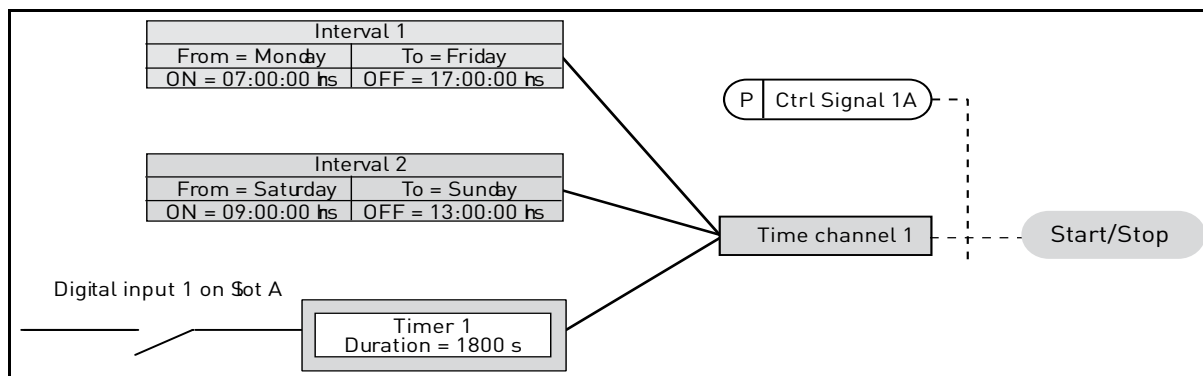

Figure 16. Final configuration where Time channel 1 is used as control signal for start command instead of a digital input.

Code	Parameter	Min	Max	Unit	Default	ID	Description
<b>3.11.1 INTERVAL 1</b>							
P3.11.1.1	ON time	00:00:00	23:59:59	hh:mm:ss	00:00:00	1464	ON time
P3.11.1.2	OFF time	00:00:00	23:59:59	hh:mm:ss	00:00:00	1465	OFF time
P3.11.1.3	From day	0	6		0	1466	ON day of week 0=Sunday 1=Monday 2=Tuesday 3=Wednesday 4=Thursday 5=Friday 6=Saturday
P3.11.1.4	To day	0	6		0	1467	See above
P3.11.1.5	Assign to channel	0	3		0	1468	Select affected time channel (1-3) 0=Not used 1=Time channel 1 2=Time channel 2 3=Time channel 3
<b>3.11.2 INTERVAL 2</b>							
P3.11.2.1	ON time	00:00:00	23:59:59	hh:mm:ss	00:00:00	1469	See Interval 1
P3.11.2.2	OFF time	00:00:00	23:59:59	hh:mm:ss	00:00:00	1470	See Interval 1
P3.11.2.3	From day	0	6		0	1471	See Interval 1
P3.11.2.4	To day	0	6		0	1472	See Interval 1
P3.11.2.5	Assign to channel	0	3		0	1473	See Interval 1

3.11.3 INTERVAL 3							
P3.11.3.1	ON time	00:00:00	23:59:59	hh:mm:ss	00:00:00	1474	See Interval 1
P3.11.3.2	OFF time	00:00:00	23:59:59	hh:mm:ss	00:00:00	1475	See Interval 1
P3.11.3.3	From day	0	6		0	1476	See Interval 1
P3.11.3.4	To day	0	6		0	1477	See Interval 1
P3.11.3.5	Assign to channel	0	3		0	1478	See Interval 1
3.11.4 INTERVAL 4							
P3.11.4.1	ON time	00:00:00	23:59:59	hh:mm:ss	00:00:00	1479	See Interval 1
P3.11.4.2	OFF time	00:00:00	23:59:59	hh:mm:ss	00:00:00	1480	See Interval 1
P3.11.4.3	From day	0	6		0	1481	See Interval 1
P3.11.4.4	To day	0	6		0	1482	See Interval 1
P3.11.4.5	Assign to channel	0	3		0	1483	See Interval 1
3.11.5 INTERVAL 5							
P3.11.5.1	ON time	00:00:00	23:59:59	hh:mm:ss	00:00:00	1484	See Interval 1
P3.11.5.2	OFF time	00:00:00	23:59:59	hh:mm:ss	00:00:00	1485	See Interval 1
P3.11.5.3	From day	0	6		0	1486	See Interval 1
P3.11.5.4	To day	0	6		0	1487	See Interval 1
P3.11.5.5	Assign to channel	0	3		0	1488	See Interval 1
3.11.6 TIMER 1							
P3.11.6.1	Duration	0	72000	s	0	1489	The time the timer will run when activated. (Activated by DI)
P3.11.6.2	Assign to channel	0	3		0	1490	Select affected time channel (1-3) 0=Not used 1=Time channel 1 2=Time channel 2 3=Time channel 3
3.11.7 TIMER 2							
P3.11.7.1	Duration	0	72000	s	0	1491	See Timer 1
P3.11.7.2	Assign to channel	0	3		0	1492	See Timer 1
3.11.8 TIMER 3							
P3.11.8.1	Duration	0	72000	s	0	1493	See Timer 1
P3.11.8.2	Assign to channel	0	3		0	1494	See Timer 1

Table 41. Timer functions

3.5.14 GROUP 3.12: PID-CONTROLLER 1

3.5.14.1 *Basic settings*

Code	Parameter	Min	Max	Unit	Default	ID	Description
P3.12.1.1	PID gain	0.00	1000.00	%	100.00	118	If the value of the parameter is set to 100% a change of 10% in the error value causes the controller output to change by 10%.
P3.12.1.2	PID integration time	0.00	600.00	s	1.00	119	If this parameter is set to 1,00 second a change of 10% in the error value causes the controller output to change by 10.00%/s.
P3.12.1.3	PID derivation time	0.00	100.00	s	0.00	132	If this parameter is set to 1,00 second a change of 10% in the error value during 1.00 s causes the controller output to change by 10.00%.
P3.12.1.4	Process unit selection	1	38		1	1036	Select unit for actual value.
P3.12.1.5	Process unit min	Varies	Varies	Varies	0	1033	
P3.12.1.6	Process unit max	Varies	Varies	Varies	100	1034	
P3.12.1.7	Process unit decimals	0	4		2	1035	Number of decimals for process unit value
P3.12.1.8	Error inversion	0	1		0	340	0 = Normal (Feedback < Setpoint -> Increase PID output) 1 = Inverted (Feedback < Setpoint -> Decrease PID output)
P3.12.1.9	Dead band hysteresis	Varies	Varies	Varies	0	1056	Dead band area around the setpoint in process units. The PID output is locked if the feedback stays within the deadband area for a pre-defined time.
P3.12.1.10	Dead band delay	0.00	320.00	s	0.00	1057	If the feedback stays within the dead band area for a pre-defined time, the output is locked.

Table 42.

3.5.14.2 *Setpoints*

Code	Parameter	Min	Max	Unit	Default	ID	Description
P3.12.2.1	Keypad setpoint 1	Varies	Varies	Varies	0	167	
P3.12.2.2	Keypad setpoint 2	Varies	Varies	Varies	0	168	
P3.12.2.3	Setpoint ramp time	0.00	300.0	s	0.00	1068	Defines the rising and falling ramp times for setpoint changes. (Time to change from minimum to maximum)
P3.12.2.4	Setpoint source 1 selection	0	16		1	332	0 = Not used 1 = Keypad setpoint 1 2 = Keypad setpoint 2 3 = AI1 4 = AI2 5 = AI3 6 = AI4 7 = AI5 8 = AI6 9 = ProcessDataIn1 10 = ProcessDataIn2 11 = ProcessDataIn3 12 = ProcessDataIn4 13 = ProcessDataIn5 14 = ProcessDataIn6 15 = ProcessDataIn7 16 = ProcessDataIn8 AI's and ProcessDataIn are handled as percent (0.00-100.00%) and scaled according to Setpoint minimum and maximum. <b>NOTE:</b> ProcessDataIn use two decimals.
P3.12.2.5	Setpoint 1 minimum	-200.00	200.00	%	0.00	1069	Minimum value at analogue signal minimum.
P3.12.2.6	Setpoint 1 maximum	-200.00	200.00	%	100.00	1070	Maximum value at analogue signal maximum.
 P3.12.2.7	Sleep frequency limit 1	0.00	320.00	Hz	0.00	1016	Drive goes to sleep mode when the output frequency stays below this limit for a time greater than that defined by parameter <i>Sleep delay</i> .
 P3.12.2.8	Sleep delay 1	0	3000	s	0	1017	The minimum amount of time the frequency has to remain below the Sleep level before the drive is stopped.
 P3.12.2.9	Wake-up level 1			Varies	0.0000	1018	Defines the level for the PID feedback value wake-up supervision. Uses selected process units.
P3.12.2.10	Setpoint 1 boost	-2.0	2.0	x	1.0	1071	The setpoint can be boosted with a digital input.
P3.12.2.11	Setpoint source 2 selection	0	16		2	431	See par. P3.12.2.4
P3.12.2.12	Setpoint 2 minimum	-200.00	200.00	%	0.00	1073	Minimum value at analogue signal minimum.

P3.12.2.13	Setpoint 2 maximum	-200.00	200.00	%	100.00	1074	Maximum value at analogue signal maximum.
P3.12.2.14	Sleep frequency limit 2	0.00	320.00	Hz	0.00	1075	See P3.12.2.7.
P3.12.2.15	Sleep delay 2	0	3000	s	0	1076	See P3.12.2.8.
P3.12.2.16	Wake-up level 2			Varies	0.0000	1077	See P3.12.2.9.
P3.12.2.17	Setpoint 2 boost	-2.0	2.0	Varies	1.0	1078	See P3.12.2.10.

*Table 43.*

3.5.14.3 *Feedbacks*

Code	Parameter	Min	Max	Unit	Default	ID	Description
P3.12.3.1	Feedback function	1	9		1	333	1=Only Source1 in use 2=SQRT(Source1);(Flow=Constant x SQRT(Pressure)) 3= SQRT(Source1- Source 2) 4= SQRT(Source 1) + SQRT (Source 2) 5= Source 1 + Source 2 6= Source 1 - Source 2 7=MIN (Source 1, Source 2) 8=MAX (Source 1, Source 2) 9=MEAN (Source 1, Source 2)
P3.12.3.2	Feedback function gain	-1000.0	1000.0	%	100.0	1058	Used e.g. with selection 2 in <i>Feedback function</i>
P3.12.3.3	Feedback 1 source selection	0	14		2	334	0 = Not used 1 = AI1 2 = AI2 3 = AI3 4 = AI4 5 = AI5 6 = AI6 7 = ProcessDataIn1 8 = ProcessDataIn2 9 = ProcessDataIn3 10 = ProcessDataIn4 11 = ProcessDataIn5 12 = ProcessDataIn6 13 = ProcessDataIn7 14 = ProcessDataIn8 AI's and ProcessDataIn are handled as % (0.00-100.00%) and scaled according to Feedback min and max. <b>NOTE:</b> ProcessDataIn use two decimals.
P3.12.3.4	Feedback 1 minimum	-200.00	200.00	%	0.00	336	Minimum value at analogue signal minimum.
P3.12.3.5	Feedback 1 maximum	-200.00	200.00	%	100.00	337	Maximum value at analogue signal maximum.
P3.12.3.6	Feedback 2 source selection	0	14		0	335	See P3.12.3.3
P3.12.3.7	Feedback 2 minimum	-200.00	200.00	%	0.00	338	Minimum value at analogue signal minimum.
P3.12.3.8	Feedback 2 maximum	-200.00	200.00	%	100.00	339	Maximum value at analogue signal maximum.

Table 44.

**3.5.14.4 Feedforward**

Feedforward usually needs accurate process models, but in some simple cases a gain + offset type of feedforward is enough. The feedforward part does not use any feedback measurements of the actual controlled process value (water level in the example on page 96). Vacon feedforward control uses other measurements which are indirectly affecting the controlled process value.

Code	Parameter	Min	Max	Unit	Default	ID	Description
P3.12.4.1	Feedforward function	1	9		1	1059	See P3.12.3.1.
P3.12.4.2	Feedforward function gain	-1000	1000	%	100.0	1060	See P3.12.3.2
P3.12.4.3	Feedforward 1 source selection	0	14		0	1061	See P3.12.3.3
P3.12.4.4	Feedforward 1 minimum	-200.00	200.00	%	0.00	1062	See P3.12.3.4
P3.12.4.5	Feedforward 1 maximum	-200.00	200.00	%	100.00	1063	See P3.12.3.5
P3.12.4.6	Feedforward 2 source selection	0	14		0	1064	See P3.12.3.6
P3.12.4.7	Feedforward 2 min	-200.00	200.00	%	0.00	1065	See P3.12.3.7
P3.12.4.8	Feedforward 2 max	-200.00	200.00	%	100.00	1066	See P3.12.3.8

Table 45.

**3.5.14.5 Process supervision**

Process supervision is used to control that the actual value stays within predefined limits. With this function you can e.g. detect a major pipe burst and stop unnecessary flooding. See more on page 96.

Code	Parameter	Min	Max	Unit	Default	ID	Description
P3.12.5.1	Enable process supervision	0	1		0	735	0 = Disabled 1 = Enabled
P3.12.5.2	Upper limit	Varies	Varies	Varies	Varies	736	Upper actual/process value supervision
P3.12.5.3	Lower limit	Varies	Varies	Varies	Varies	758	Lower actual/process value supervision
P3.12.5.4	Delay	0	30000	s	0	737	If the desired value is not reached within this time a fault or alarm is created.

Table 46.

3.5.14.6 *Pressure loss compensation*

Code	Parameter	Min	Max	Unit	Default	ID	Description
P3.12.6.1	Enable setpoint 1	0	1		0	1189	Enables pressure loss compensation for setpoint 1. 0 = Disabled 1 = Enabled
P3.12.6.2	Setpoint 1 max compensation	Varies	Varies	Varies	Varies	1190	Value added proportionally to the frequency. Setpoint compensation = Max compensation * (FreqOut - MinFreq)/(MaxFreq - MinFreq)
P3.12.6.3	Enable setpoint 2	0	1		0	1191	See P3.12.6.1.
P3.12.6.4	Setpoint 2 max compensation	Varies	Varies	Varies	Varies	1192	See P3.12.6.2.

Table 47.

**3.5.15 GROUP 3.13: PID-CONTROLLER 2**

**3.5.15.1 Basic settings**

For more detailed information, see chapter 3.5.14.

Code	Parameter	Min	Max	Unit	Default	ID	Description
P3.13.1.1	Enable PID	0	1		0	1630	0 = Disabled 1 = Enabled
P3.13.1.2	Output in Stop	0.0	100.0	%	0.0	1100	The output value of the PID controller in % of its maximum output value while it is stopped from digital input
P3.13.1.3	PID gain	0.00	1000.00	%	100.00	1631	
P3.13.1.4	PID integration time	0.00	600.00	s	1.00	1632	
P3.13.1.5	PID derivation time	0.00	100.00	s	0.00	1633	
P3.13.1.6	Process unit selection	1	38		1	1635	
P3.13.1.7	Process unit min	Varies	Varies	Varies	0	1664	
P3.13.1.8	Process unit max	Varies	Varies	Varies	100	1665	
P3.13.1.9	Process unit decimals	0	4		2	1666	
P3.13.1.10	Error inversion	0	1		0	1636	
P3.13.1.11	Dead band hysteresis	Varies	Varies	Varies	0.0	1637	
P3.13.1.12	Dead band delay	0.00	320.00	s	0.00	1638	

Table 48.

**3.5.15.2 Setpoints**

Code	Parameter	Min	Max	Unit	Default	ID	Description
P3.13.2.1	Keypad setpoint 1	0.00	100.00	Varies	0.00	1640	
P3.13.2.2	Keypad setpoint 2	0.00	100.00	Varies	0.00	1641	
P3.13.2.3	Setpoint ramp time	0.00	300.00	s	0.00	1642	
P3.13.2.4	Setpoint source 1 selection	0	16		1	1643	
P3.13.2.5	Setpoint 1 minimum	-200.00	200.00	%	0.00	1644	Minimum value at analogue signal minimum.
P3.13.2.6	Setpoint 1 maximum	-200.00	200.00	%	100.00	1645	Maximum value at analogue signal maximum.
P3.13.2.7	Setpoint source 2 selection	0	16		0	1646	See P3.13.2.4.
P3.13.2.8	Setpoint 2 minimum	-200.00	200.00	%	0.00	1647	Minimum value at analogue signal minimum.
P3.13.2.9	Setpoint 2 maximum	-200.00	200.00	%	100.00	1648	Maximum value at analogue signal maximum.

Table 49.

**3.5.15.3 Feedbacks**

For more detailed information, see chapter 3.5.14.

Code	Parameter	Min	Max	Unit	Default	ID	Description
P3.13.3.1	Feedback function	1	9		1	1650	
P3.13.3.2	Feedback function gain	-1000.0	1000.0	%	100.0	1651	
P3.13.3.3	Feedback 1 source selection	0	14		1	1652	
P3.13.3.4	Feedback 1 minimum	-200.00	200.00	%	0.00	1653	Minimum value at analogue signal minimum.
P3.13.3.5	Feedback 1 maximum	-200.00	200.00	%	100.00	1654	Maximum value at analogue signal maximum.
P3.13.3.6	Feedback 2 source selection	0	14		2	1655	
P3.13.3.7	Feedback 2 minimum	-200.00	200.00	%	0.00	1656	Minimum value at analogue signal minimum.
P3.13.3.8	Feedback 2 maximum	-200.00	200.00	%	100.00	1657	Maximum value at analogue signal maximum.

Table 50.

**3.5.15.4 Process supervision**

For more detailed information, see chapter 3.5.14.

Code	Parameter	Min	Max	Unit	Default	ID	Description
P3.13.4.1	Enable supervision	0	1		0	1659	0 = Disabled 1 = Enabled
P3.13.4.2	Upper limit	Varies	Varies	Varies	Varies	1660	
P3.13.4.3	Lower limit	Varies	Varies	Varies	Varies	1661	
P3.13.4.4	Delay	0	30000	s	0	1662	If the desired value is not reached within this time a fault or alarm is activated.

Table 51.

**3.5.16 GROUP 3.14: MULTI-PUMP**

The *Multi-pump* functionality allows you to control **up to 4 motors** (pumps, fans) with PID controller 1. The AC drive is connected to one motor which is the "regulating" motor connecting and disconnecting the other motors to/from the mains, by means of contactors controlled with relays when needed in order to maintain the right setpoint. The *Autochange* function controls the order/priority in which the motors are started in order to guarantee their equal wear. The controlling motor **can be included** in the autochange and interlocks logic, or, it may be selected to always functions as Motor 1. Motors can be taken out of use momentarily, e.g. for service, using the motor *Interlock function*. See page 99.



Code	Parameter	Min	Max	Unit	Default	ID	Description
P3.14.1	Number of motors	1	4		1	1001	Total number of motors (pumps/fans) used in multi-pump system
P3.14.2	Interlock function	0	1		1	1032	Enable/Disable use of interlocks. Interlocks are used to tell the system if a motor is connected or not. 0 = Disabled 1 = Enabled
P3.14.3	Include FC	0	1		1	1028	Include the frequency converter in the autochange and interlocking system. 0 = Disabled 1 = Enabled
P3.14.4	Autochange	0	1		0	1027	Disable/enable rotation of starting order and priority of motors. 0 = Disabled 1 = Enabled
P3.14.5	Autochange interval	0.0	3000.0	h	48.0	1029	After the expiry of the time defined with this parameter, the autochange function takes place if the capacity used lies below the level defined with parameters P3.14.6 and P3.14.7.
P3.14.6	Autochange: Frequency limit	0.00	50.00	Hz	25.00	1031	These parameters define the level below which the capacity used must remain so that the autochange can take place.
P3.14.7	Autochange: Motor limit	0	4		1	1030	
P3.14.8	Bandwidth	0	100	%	10	1097	Percentage of the setpoint. E.g.: Setpoint = 5 bar, Bandwidth = 10%: As long as the feedback value stays within 4.5...5.5 bar motor disconnection or removal will not take place.
P3.14.9	Bandwidth delay	0	3600	s	10	1098	With feedback outside the bandwidth, this time must pass before pumps are added or removed.

Table 52. Multi-pump parameters

**3.5.17 GROUP 3.16: FIRE MODE**

Drive ignores all commands from keypad, fieldbuses and PC tool and runs at preset frequency when activated. If activated, alarm sign is shown on the keypad and **warranty is void**. In order to enable the function, you need to set a password in the description field for parameter *Fire Mode password*. Please note the NC (normally closed) type of this input!

**NOTE! THE WARRANTY IS VOID IF THIS FUNCTION IS ACTIVATED!** There is also a different password for test mode to be used for testing the Fire Mode without the warranty becoming void.

Code	Parameter	Min	Max	Unit	Default	ID	Description
P3.16.1	Fire Mode password	0	9999		0	1599	1001 = Enabled 1234 = Test mode
P3.16.2	Fire Mode activation				DigIN Slot0.2	1596	FALSE = Fire Mode active TRUE = No action
P3.16.3	Fire Mode frequency	8.00	P3.3.2	Hz	0.00	1598	Frequency used when Fire Mode is activated.
P3.16.4	Fire Mode frequency source	0	8		0	1617	Selection of reference source when Fire Mode is active. This enables selection of e.g. AI1 or PID controller as reference source also while operating in Fire Mode. 0 = Fire Mode frequency 1 = Preset speeds 2 = Keypad 3 = Fieldbus 4 = AI1 5 = AI2 6 = AI1 + AI2 7 = PID1 8 = Motor potentiometer
P3.16.5	Fire Mode reverse				DigIN Slot0.1	1618	Reverse command of rotation direction while running in Fire Mode. This function has no effect in normal operation. FALSE = Forward TRUE = Reverse
P3.16.6	Fire Mode status	0	3		0	1597	Monitoring value (see also Table 16) 0=Disabled 1=Enabled 2=Activated (Enabled + DI Open) 3=Test Mode

Table 53. Fire mode parameters

**3.5.18 GROUP 3.17: APPLICATION SETTINGS**

Code	Parameter	Min	Max	Unit	Default	ID	Description
P3.17.1	Password	0	9999		0	1806	

*Table 54. Application settings*

### 3.6 HVAC APPLICATION - ADDITIONAL PARAMETER INFORMATION

Due to its user-friendliness and simplicity of use, the most parameters of the Vacon HVAC Application only require a basic description which is given in the parameter tables in chapter 3.5. In this chapter, you will find additional information on certain most advanced parameters of the Vacon HVAC Application. Should you not find the information you need contact your distributor.

#### P3.1.1.7 MOTOR CURRENT LIMIT

This parameter determines the maximum motor current from the AC drive. The parameter value range differs from size to size.

When the current limit is active the drive output frequency is decreased.

**NOTE:** This is not an overcurrent trip limit.

#### P3.1.2.9 U/F RATIO SELECTION

Selection number	Selection name	Description
0	Linear	The voltage of the motor changes linearly as a function of output frequency from zero frequency voltage (P3.1.2.4) to the field weakening point (FWP) voltage at FWP frequency. This default setting should be used if there is no special need for another setting.
1	Squared	The voltage of the motor changes from zero point voltage (P3.1.2.4) following a squared curve form from zero to the field weakening point. The motor runs undermagnetised below the field weakening point and produces less torque. Squared U/f ratio can be used in applications where torque demand is proportional to the square of the speed, e.g. in centrifugal fans and pumps.

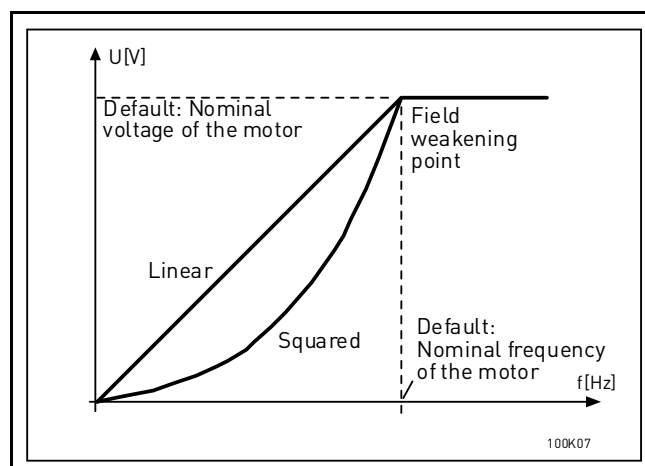

Figure 17. Linear and squared change of motor voltage

**P3.1.2.15    OVERVOLTAGE CONTROLLER****P3.1.2.16    UNDERVOLTAGE CONTROLLER**

These parameters allow the under-/overvoltage controllers to be switched out of operation. This may be useful, for example, if the mains supply voltage varies more than -15% to +10% and the application will not tolerate this over-/undervoltage. In this case, the regulator controls the output frequency taking the supply fluctuations into account.

**P3.2.5        STOP FUNCTION**

Selection number	Selection name	Description
0	Coasting	The motor is allowed to stop on its own inertia. The control by the drive is discontinued and the drive current drops to zero as soon as the stop command is given.
1	Ramp	After the Stop command, the speed of the motor is decelerated according to the set deceleration parameters to zero speed.

**P3.2.6        I/O A START/STOP LOGIC**

Values 0...4 offer possibilities to control the starting and stopping of the AC drive with digital signal connected to digital inputs. CS = Control signal.

The selections including the text 'edge' shall be used to exclude the possibility of an unintentional start when, for example, power is connected, re-connected after a power failure, after a fault reset, after the drive is stopped by Run Enable (Run Enable = False) or when the control place is changed to I/O control. **The Start/Stop contact must be opened before the motor can be started.**

The used stop mode is *Coasting* in all examples.

Selection number	Selection name	Note
0	CS1: Forward CS2: Backward	The functions take place when the contacts are closed.

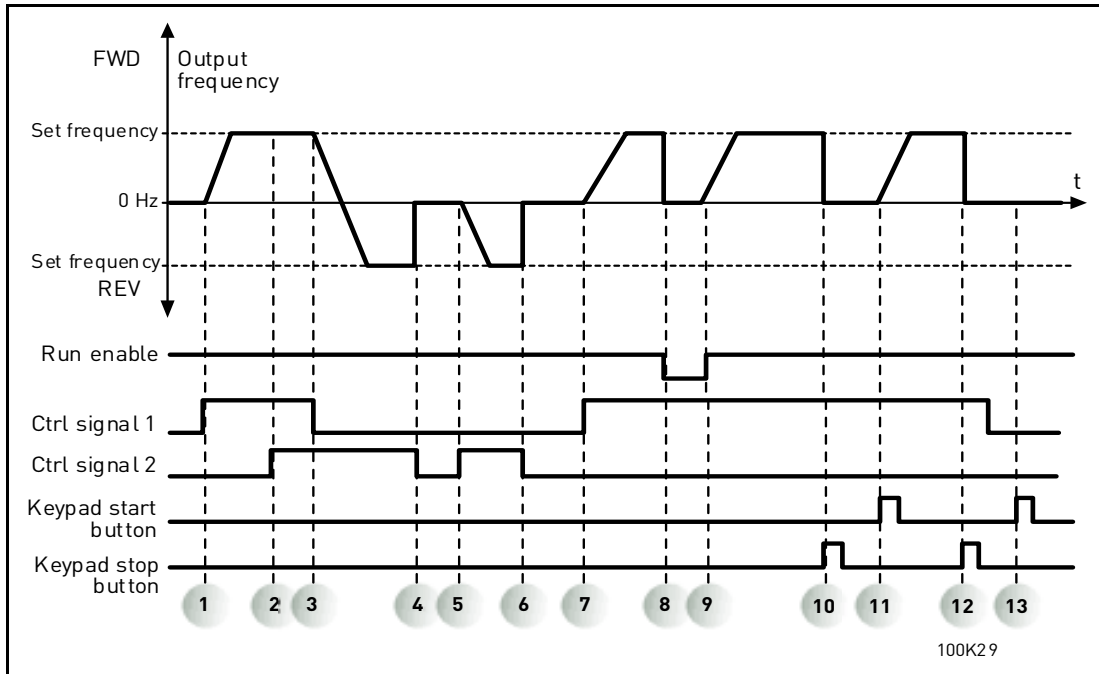

Figure 18. I/O A Start/Stop logic = 0

**Explanations:**

1	Control signal (CS) 1 activates causing the output frequency to rise. The motor runs forward.	8	Run enable signal is set to FALSE, which drops the frequency to 0. The run enable signal is configured with parameter P3.5.1.10.
2	CS2 activates which, however, has no effect on the output frequency because the first selected direction has the highest priority.	9	Run enable signal is set to TRUE, which causes the frequency to rise towards the set frequency because CS1 is still active.
3	CS1 is inactivated which causes the direction to start changing (FWD to REV) because CS2 is still active.	10	Keypad stop button is pressed and the frequency fed to the motor drops to 0. (This signal only works if P3.2.3 Keypad stop button = Yes)
4	CS2 inactivates and the frequency fed to the motor drops to 0.	11	The drive starts through pushing the Start button on the keypad.
5	CS2 activates again causing the motor to accelerate (REV) towards the set frequency.	12	The keypad stop button is pushed again to stop the drive.
6	CS2 inactivates and the frequency fed to the motor drops to 0.	13	The attempt to start the drive through pushing the Start button is not successful because CS1 is inactive.
7	CS1 activates and the motor accelerates (FWD) towards the set frequency		

Selection number	Selection name	Note
1	CS1: Forward (edge) CS2: Inverted stop	

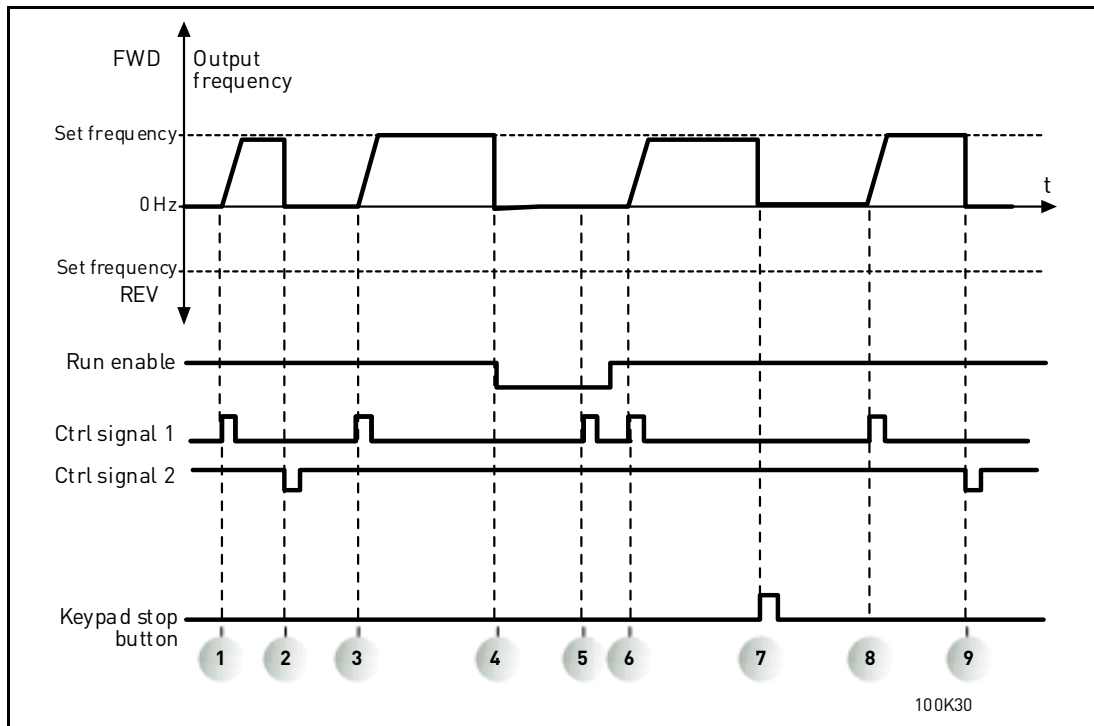

Figure 19. I/O A Start/Stop logic = 1

**Explanations:**

1	Control signal (CS) 1 activates causing the output frequency to rise. The motor runs forward.	6	CS1 activates and the motor accelerates (FWD) towards the set frequency because the Run enable signal has been set to TRUE.
2	CS2 inactivates causing the frequency to drop to 0.	7	Keypad stop button is pressed and the frequency fed to the motor drops to 0. (This signal only works if P3.2.3 Keypad stop button = Yes)
3	CS1 activates causing the output frequency to rise again. The motor runs forward.	8	CS1 activates causing the output frequency to rise again. The motor runs forward.
4	Run enable signal is set to FALSE, which drops the frequency to 0. The run enable signal is configured with parameter P3.5.1.10.	9	CS2 inactivates causing the frequency to drop to 0.
5	Start attempt with CS1 is not successful because Run enable signal is still FALSE.		

Selection number	Selection name	Note
2	CS1: Forward (edge) CS2: Backward (edge)	Shall be used to exclude the possibility of an unintentional start. The Start/Stop contact must be opened before the motor can be restarted.

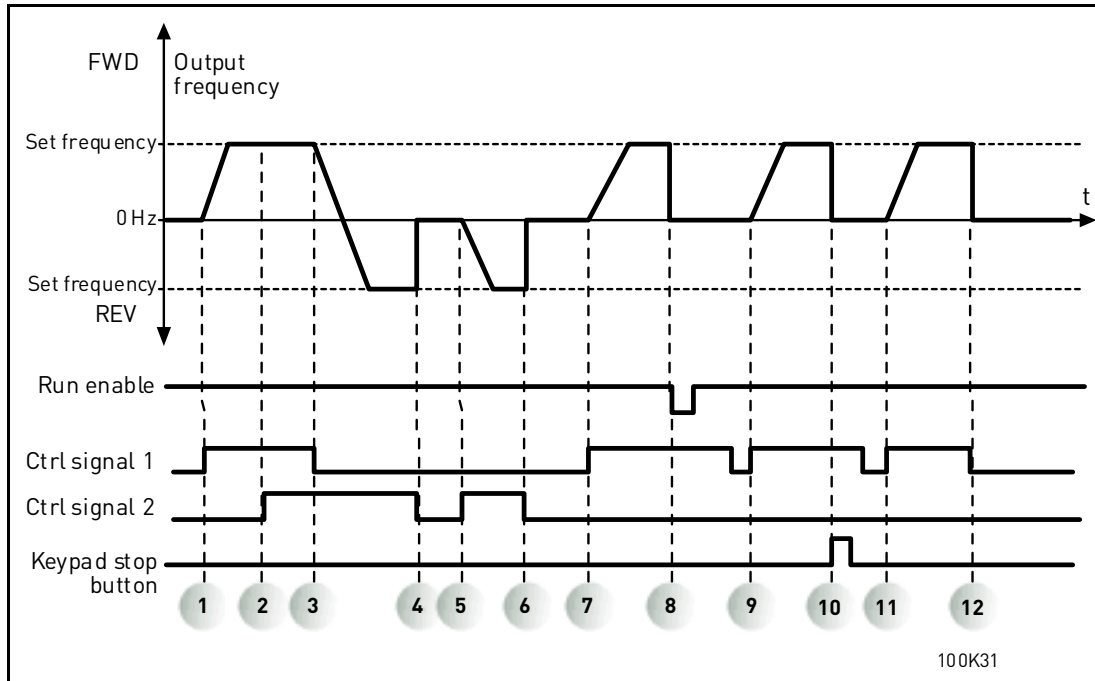

Figure 20. I/O A Start/Stop logic = 2

**Explanations:**

1	Control signal (CS) 1 activates causing the output frequency to rise. The motor runs forward.	7	CS1 activates and the motor accelerates (FWD) towards the set frequency
2	CS2 activates which, however, has no effect on the output frequency because the first selected direction has the highest priority.	8	Run enable signal is set to FALSE, which drops the frequency to 0. The run enable signal is configured with parameter P3.5.1.10.
3	CS1 is inactivated which causes the direction to start changing (FWD to REV) because CS2 is still active.	9	Run enable signal is set to TRUE, which, unlike if value 0 is selected for this parameter, has no effect because rising edge is required to start even if CS1 is active.
4	CS2 inactivates and the frequency fed to the motor drops to 0.	10	Keypad stop button is pressed and the frequency fed to the motor drops to 0. (This signal only works if P3.2.3 Keypad stop button = Yes)
5	CS2 activates again causing the motor to accelerate (REV) towards the set frequency.	11	CS1 is opened and closed again which causes the motor to start.
6	CS2 inactivates and the frequency fed to the motor drops to 0.	12	CS1 inactivates and the frequency fed to the motor drops to 0.

Selection number	Selection name	Note
3	CS1: Start CS2: Reverse	

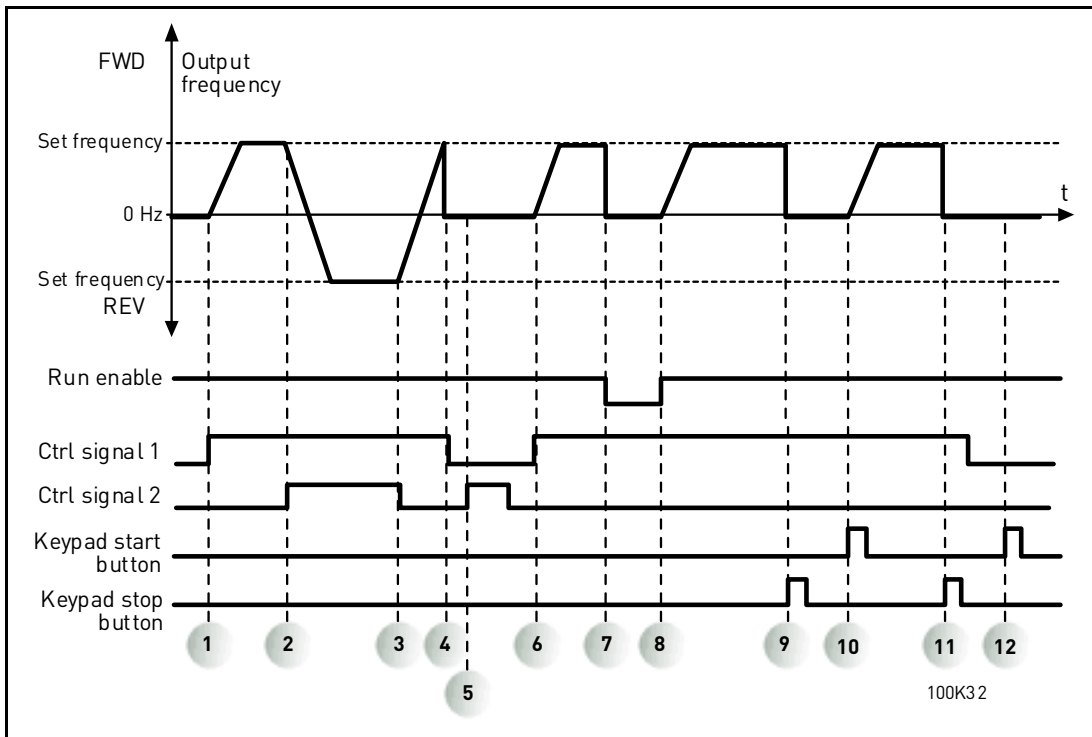

Figure 21. I/O A Start/Stop logic = 3

1	Control signal (CS) 1 activates causing the output frequency to rise. The motor runs forward.	7	Run enable signal is set to FALSE, which drops the frequency to 0. The run enable signal is configured with parameter P3.5.1.10.
2	CS2 activates which causes the direction to start changing (FWD to REV).	8	Run enable signal is set to TRUE, which causes the frequency to rise towards the set frequency because CS1 is still active.
3	CS2 is inactivated which causes the direction to start changing (REV to FWD) because CS1 is still active.	9	Keypad stop button is pressed and the frequency fed to the motor drops to 0. (This signal only works if P3.2.3 Keypad stop button = Yes)
4	Also CS1 inactivates and the frequency drops to 0.	10	The drive starts through pushing the Start button on the keypad.
5	Despite the activation of CS2, the motor does not start because CS1 is inactive.	11	The drive is stopped again with the stop button on the keypad.
6	CS1 activates causing the output frequency to rise again. The motor runs forward because CS2 is inactive.	12	The attempt to start the drive through pushing the Start button is not successful because CS1 is inactive.

Selection number	Selection name	Note
4	CS1: Start (edge) CS2: Reverse	Shall be used to exclude the possibility of an unintentional start. The Start/Stop contact must be opened before the motor can be restarted.

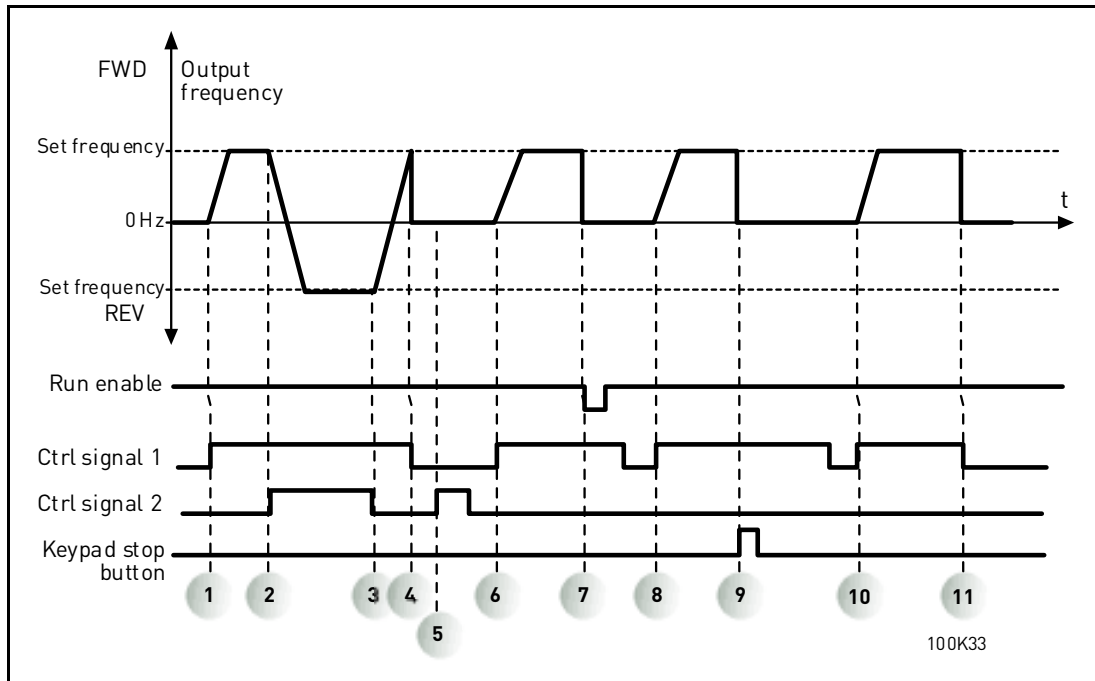

Figure 22. I/O A Start/Stop logic = 4

1	Control signal (CS) 1 activates causing the output frequency to rise. The motor runs forward because CS2 is inactive.	7	Run enable signal is set to FALSE, which drops the frequency to 0. The run enable signal is configured with parameter P3.5.1.10.
2	CS2 activates which causes the direction to start changing (FWD to REV).	8	Before a successful start can take place, CS1 must be opened and closed again.
3	CS2 is inactivated which causes the direction to start changing (REV to FWD) because CS1 is still active.	9	Keypad stop button is pressed and the frequency fed to the motor drops to 0. (This signal only works if P3.2.3 Keypad stop button = Yes)
4	Also CS1 inactivates and the frequency drops to 0.	10	Before a successful start can take place, CS1 must be opened and closed again.
5	Despite the activation of CS2, the motor does not start because CS1 is inactive.	11	CS1 inactivates and the frequency drops to 0.
6	CS1 activates causing the output frequency to rise again. The motor runs forward because CS2 is inactive.		

**P3.3.10 PRESET FREQUENCY MODE**

You can use the preset frequency parameters to define certain frequency references in advance. These references are then applied by activating/inactivating digital inputs connected to parameters P3.5.1.15, P3.5.1.16 and P3.5.1.17 (*Preset frequency selection 0, Preset frequency selection 1 and Preset frequency selection 2*). Two different logics can be selected:

Selection number	Selection name	Note
0	Binary coded	Combine activated inputs according to Table 55 to choose the Preset frequency needed.
1	Number (of inputs used)	According to how many of the inputs assigned for <i>Preset frequency selections</i> are active you can apply the <i>Preset frequencies 1 to 3</i> .

**P3.3.11 TO P3.3.18 PRESET FREQUENCIES 1 TO 7**

The values of the preset frequencies are automatically limited between the minimum and maximum frequencies (P3.3.1 and P3.3.2). See table below.

Required action			Activated frequency
Choose value 1 for parameter P3.3.3			Preset frequency 0
B2	B1	B0	Preset frequency 1
B2	B1	B0	Preset frequency 2
B2	B1	B0	Preset frequency 3
B2	B1	B0	Preset frequency 4
B2	B1		Preset frequency 5
B2	B1	B0	Preset frequency 6
B2	B1	B0	Preset frequency 7

Table 55. Selection of preset frequencies; ■ = input activated

**P3.4.1 RAMP 1 SHAPE**

The start and end of acceleration and deceleration ramps can be smoothed with this parameter. Setting value 0 gives a linear ramp shape which causes acceleration and deceleration to act immediately to the changes in the reference signal.

Setting value 0.1...10 seconds for this parameter produces an S-shaped acceleration/deceleration. The acceleration time is determined with parameters P3.4.2 and P3.4.3. See Figure 23.

These parameters are used to reduce mechanical erosion and current spikes when the reference is changed.

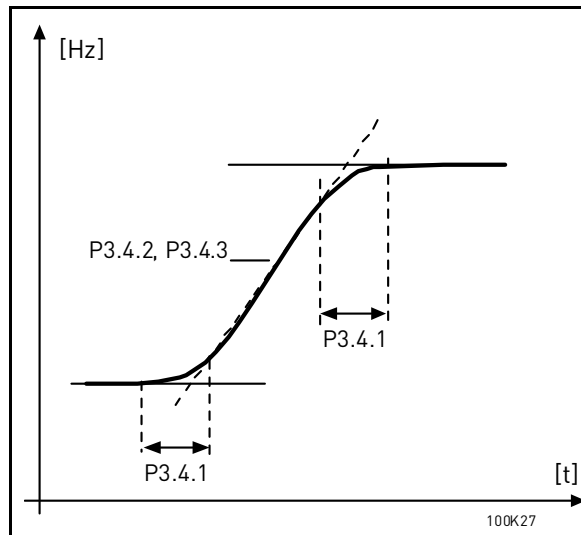

Figure 23. Acceleration/Deceleration (S-shaped)

**P3.4.12 FLUX BRAKING**

Instead of DC braking, flux braking is a useful way to raise the braking capacity in cases where additional brake resistors are not needed.

When braking is needed, the frequency is reduced and the flux in the motor is increased, which in turn increases the motor's capability to brake. Unlike DC braking, the motor speed remains controlled during braking.

The flux braking can be set ON or OFF.

**NOTE:** Flux braking converts the energy into heat at the motor, and should be used intermittently to avoid motor damage.

**P3.5.1.10 RUN ENABLE**

Contact open: Start of motor **disabled**  
 Contact closed: Start of motor **enabled**

The frequency converter is stopped according to the selected function at P3.2.5. The follower drive will always coast to stop.

**P3.5.1.11 RUN INTERLOCK 1**

**P3.5.1.12 RUN INTERLOCK 2**

The drive cannot be started if any of the interlocks are open.

The function could be used for a damper interlock, preventing the drive to start with damper closed.

**P3.5.1.15 PRESET FREQUENCY SELECTION 0**

**P3.5.1.16 PRESET FREQUENCY SELECTION 1**

**P3.5.1.17 PRESET FREQUENCY SELECTION 2**

Connect a digital input to these functions with the programming method presented in chapter 3.5.2 to be able to apply Preset frequencies 1 to 7 (see Table 55 and pages 46, 49 and 85).

**P3.5.2.2 AI1 SIGNAL FILTER TIME**

When this parameter is given a value greater than 0 the function that filters out disturbances from the incoming analogue signal is activated.

**NOTE: Long filtering time makes the regulation response slower!**

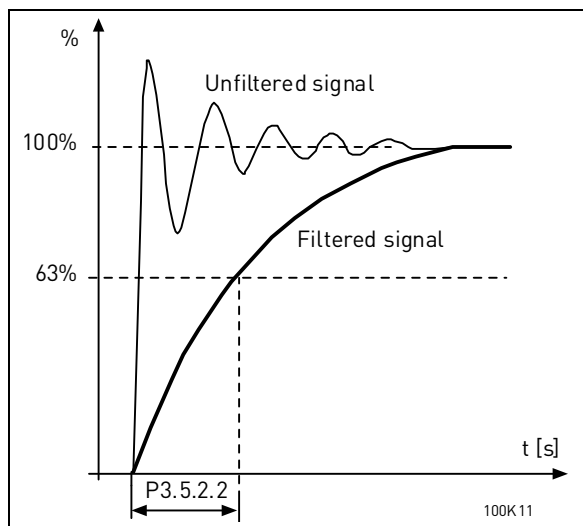

Figure 24. AI1 signal filtering

**P3.5.3.2.1 BASIC R01 FUNCTION**

Selection	Selection name	Description
0	Not used	
1	Ready	The frequency converter is ready to operate
2	Run	The frequency converter operates (motor is running)
3	General fault	A fault trip has occurred
4	General fault inverted	A fault trip has <b>not</b> occurred
5	General alarm	
6	Reversed	The reverse command has been selected
7	At speed	The output frequency has reached the set reference
8	Motor regulator activated	One of the limit regulators (e.g. current limit, torque limit) is activated
9	Preset frequency active	The preset frequency has been selected with digital input
10	Keypad control active	Keypad control mode selected
11	I/O control B active	I/O control place B selected
12	Limit supervision 1	Activates if the signal value falls below or exceeds the set supervision limit (P3.8.3 or P3.8.7) depending on the selected function.
13	Limit supervision 2	
14	Start command active	Start command is active.
15	Reserved	
16	Fire mode ON	

Selection	Selection name	Description
17	RTC timer 1 control	Time channel 1 is used.
18	RTC timer 2 control	Time channel 2 is used.
19	RTC timer 3 control	Time channel 3 is used.
20	FB Control WordB.13	
21	FB Control WordB.14	
22	FB Control WordB.15	
23	PID1 in Sleep mode	
24	Reserved	
25	PID1 supervision limits	PID1 feedback value is beyond supervision limits.
26	PID2 supervision limits	PID2 feedback value is beyond supervision limits.
27	Motor 1 control	Contact control for <i>Multi-pump</i> function
28	Motor 2 control	Contact control for <i>Multi-pump</i> function
29	Motor 3 control	Contact control for <i>Multi-pump</i> function
30	Motor 4 control	Contact control for <i>Multi-pump</i> function
31	Reserved	(Always open)
32	Reserved	(Always open)
33	Reserved	(Always open)
34	Maintenance warning	
35	Maintenance fault	

Table 56. Output signals via RO1

### **P3.9.2      RESPONSE TO EXTERNAL FAULT**

An alarm message or a fault action and message is generated by an external fault external fault signal in one of the programmable digital inputs (DI3 by default) using parameters P3.5.1.7 and P3.5.1.8. The information can also be programmed into any of the relay outputs.

### **P3.9.8      MOTOR THERMAL ZERO SPEED COOLING**

Defines the cooling factor at zero speed in relation to the point where the motor is running at nominal speed without external cooling. See .

The default value is set assuming that there is no external fan cooling the motor. If an external fan is used this parameter can be set to 90% (or even higher).

If you change the parameter P3.1.1.4 (*Motor nominal current*), this parameter is automatically restored to the default value.

Setting this parameter does not affect the maximum output current of the drive which is determined by parameter P3.1.1.7 alone.

The corner frequency for the thermal protection is 70% of the motor nominal frequency (P3.1.1.2).

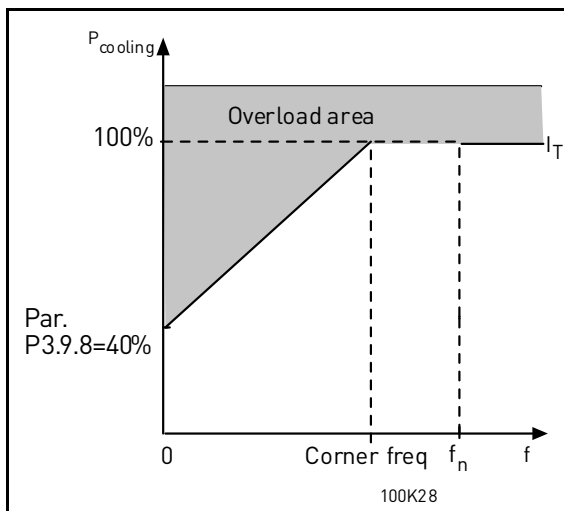

Figure 25. Motor thermal current  $I_T$  curve

**P3.9.9 MOTOR THERMAL TIME CONSTANT**

The time constant is the time within which the calculated thermal stage has reached 63% of its final value. The bigger the frame and/or slower the speed of the motor, the longer the time constant.

The motor thermal time is specific to the motor design and it varies between different motor manufacturers. The default value of the parameter varies from size to size.

If the motor's  $t_6$ -time ( $t_6$  is the time in seconds the motor can safely operate at six times the rated current) is known (given by the motor manufacturer) the time constant parameter can be set basing on it. As a rule of thumb, the motor thermal time constant in minutes equals to  $2 \cdot t_6$ . If the drive is in stop stage the time constant is internally increased to three times the set parameter value. The cooling in stop stage is based on convection and the time constant is increased.

See Figure 26.

**P3.9.10 MOTOR THERMAL LOADABILITY**

Setting value to 130% means that the nominal temperature will be reached with 130% of motor nominal current.

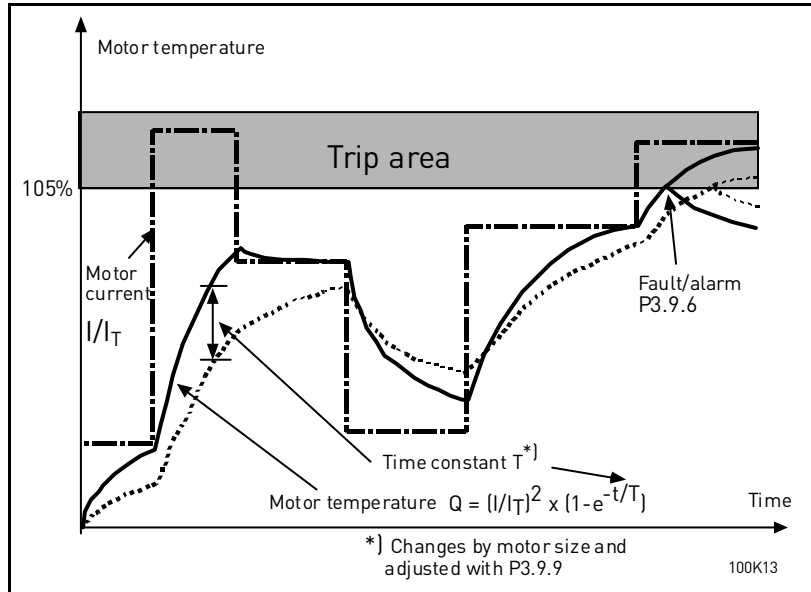

Figure 26. Motor temperature calculation

**P3.9.12 STALL CURRENT**

The current can be set to 0.0...2\*I<sub>L</sub>. For a stall stage to occur, the current must have exceeded this limit. See Figure 27. If parameter P3.1.1.7 *Motor current limit* is changed, this parameter is automatically calculated to 90% of the current limit. See page 59.

**NOTE!** In order to guarantee desired operation, this limit must be set below the current limit.

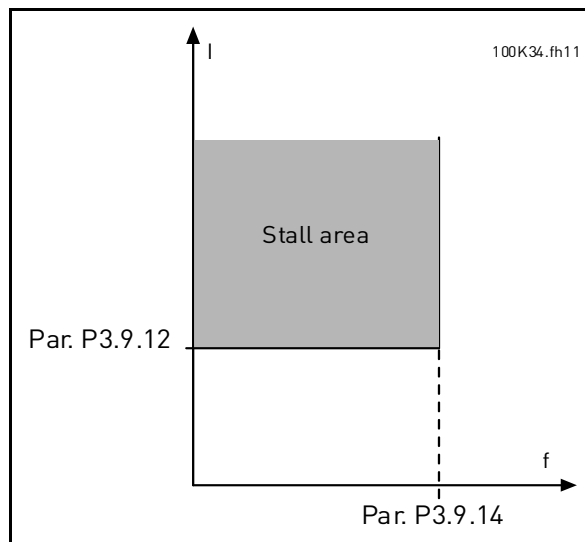

Figure 27. Stall characteristics settings

**P3.9.13 STALL TIME LIMIT**

This time can be set between 1.0 and 120.0s.

This is the maximum time allowed for a stall stage. The stall time is counted by an internal up/down counter.

If the stall time counter value goes above this limit the protection will cause a trip (see P3.9.11). See page 59.

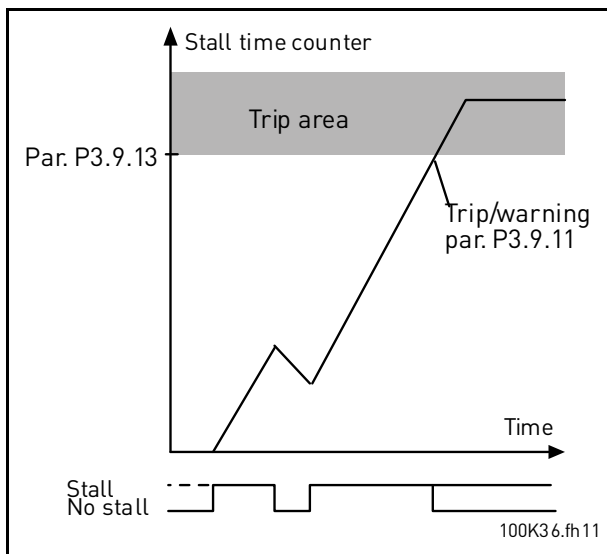

Figure 28. Stall time count

**P3.9.16 UNDERLOAD PROTECTION: FIELD WEAKENING AREA LOAD**

The torque limit can be set between 10.0-150.0 % x  $T_{nMotor}$ .

This parameter gives the value for the minimum torque allowed when the output frequency is above the field weakening point. See Figure 29.

If you change parameter P3.1.1.4 (*Motor nominal current*) this parameter is automatically restored to the default value. See page 59.

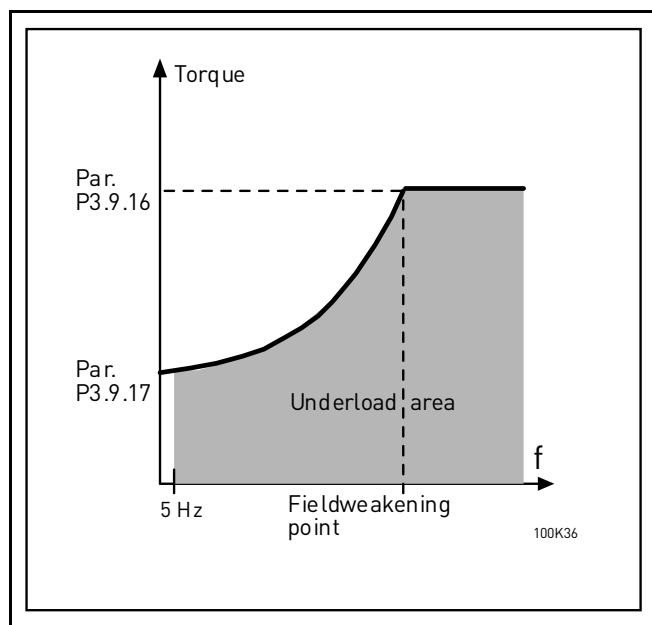

Figure 29. Setting of minimum load

**P3.9.18 UNDERLOAD PROTECTION: TIME LIMIT**

This time can be set between 2.0 and 600.0 s.

This is the maximum time allowed for an underload state to exist. An internal up/down counter counts the accumulated underload time. If the underload counter value goes above this limit

the protection will cause a trip according to parameter P3.9.15). If the drive is stopped the underload counter is reset to zero. See Figure 30 and page 59.

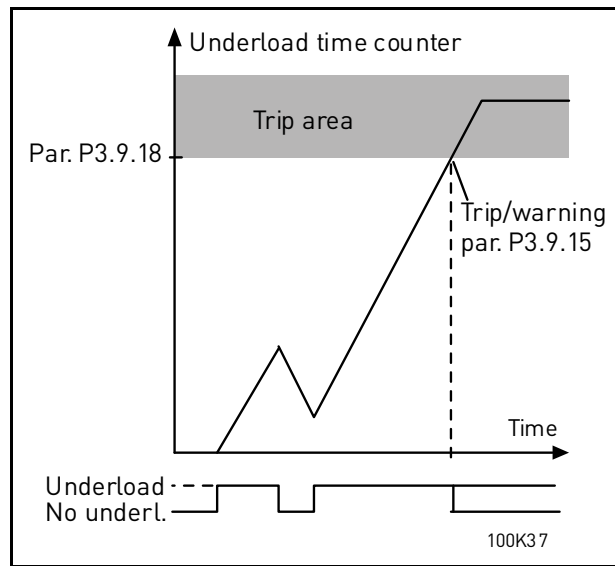

Figure 30. Underload time counter function

**P3.10.1 AUTOMATIC RESET**

Activate the *Automatic reset* after fault with this parameter.

**NOTE:** Automatic reset is allowed for certain faults only. By giving the parameters P3.10.6 to P3.10.13 the value **0** or **1** you can either allow or deny the automatic reset after the respective faults.

- P3.10.3 WAIT TIME**
- P3.10.4 AUTOMATIC RESET: TRIAL TIME**
- P3.10.5 NUMBER OF TRIALS**

The Automatic reset function keeps resetting the faults appearing during the time set with this parameter. If the number of faults during the trial time exceed the value of parameter P3.10.5 a permanent fault is generated. Otherwise the fault is cleared after the trial time has elapsed and the next fault starts the trial time count again.

Parameter P3.10.5 determines the maximum number of automatic fault reset attempts during the trial time set by this parameter. The time count starts from the first autoreset. The maximum number is independent of the fault type.

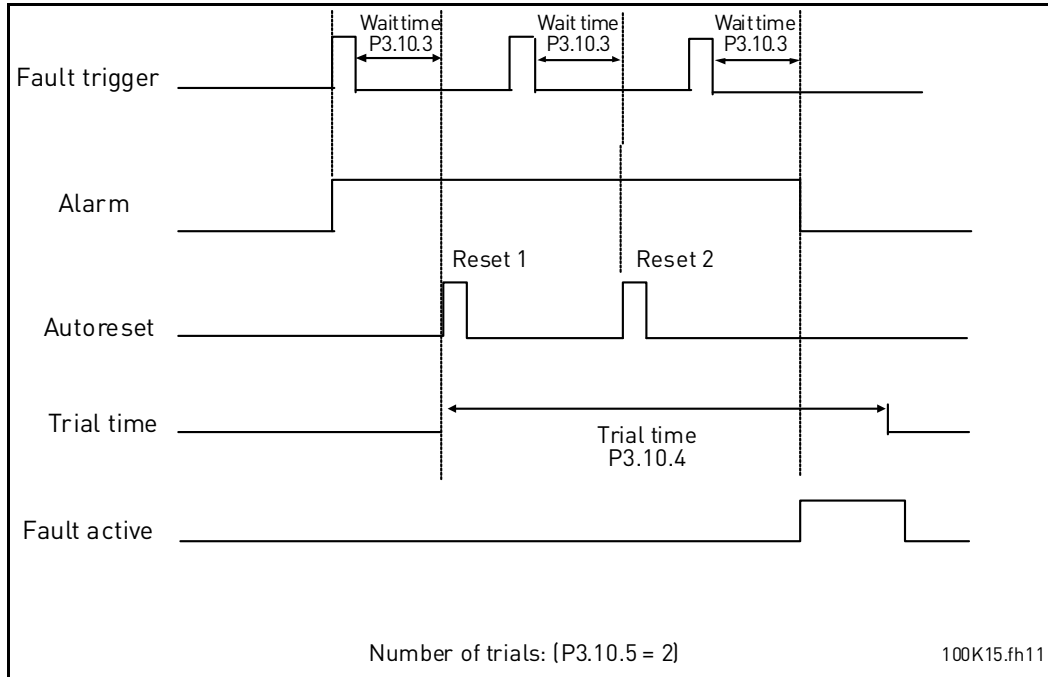

Figure 31. Automatic reset function

**P3.12.1.9 DEAD BAND HYSTERESIS**

**P3.12.1.10 DEAD BAND DELAY**

The PID controller output is locked if the actual value stays within the deadband area around the reference for a predefined time. This function will prevent unnecessary movement and wear on actuators, e.g. valves.

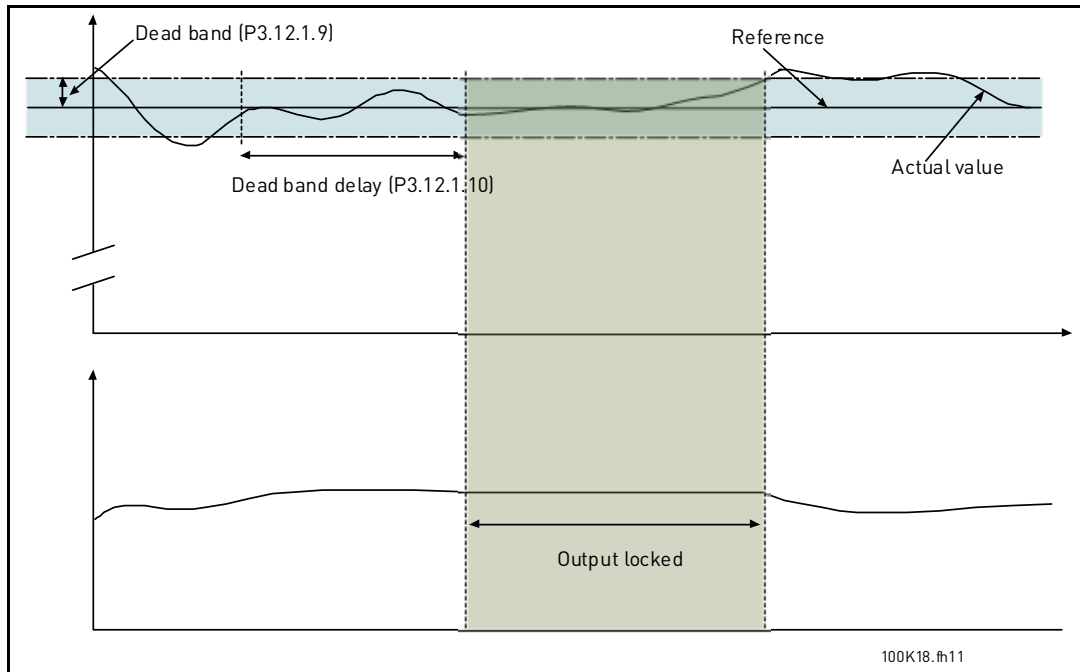

Figure 32. Dead band

**P3.12.2.7 SLEEP FREQUENCY LIMIT 1**

**P3.12.2.8 SLEEP DELAY 1**

**P3.12.2.9 WAKE-UP LEVEL 1**

This function will put the drive into sleep mode if the frequency stays below the sleep limit for a longer time than that set with the Sleep Delay (P3.12.2.8). This means that the start command remains on, but the run request is turned off. When the actual value goes below, or above, the wake-up level depending on the set acting mode the drive will activate the run request again if the start command is still on.

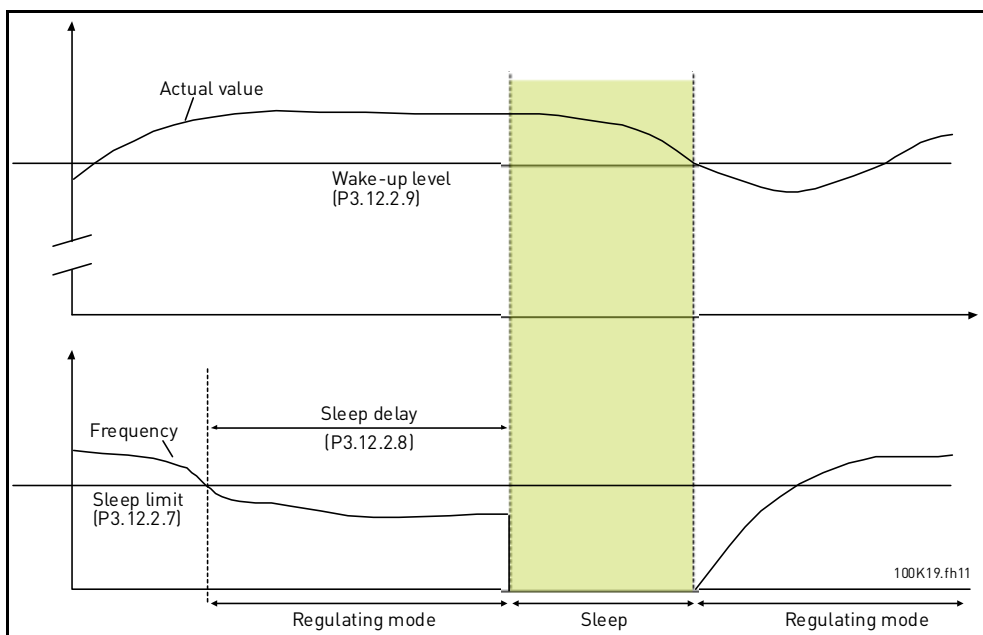

Figure 33. Sleep limit, Sleep delay, Wake-up level

**P3.12.4.1 FEEDFORWARD FUNCTION**

Feedforward usually needs accurate process models, but in some simple cases a gain + offset type of feedforward is enough. The feedforward part does not use any feedback measurements of the actual controlled process value (water level in the example on page 96). Vacon feedforward control uses other measurements which are indirectly affecting the controlled process value.

**Example 1:**

Controlling the water level of a tank by means of flow control. The desired water level has been defined as a setpoint and the actual level as feedback. The control signal acts on the incoming flow.

The outflow could be thought of as a disturbance that can be measured. Based on the measurements of the disturbance, we can try to compensate for this disturbance by simple feedforward control (gain and offset) which is added to the PID output.

This way the controller would react much faster to changes in the outflow than if you just had measured the level.

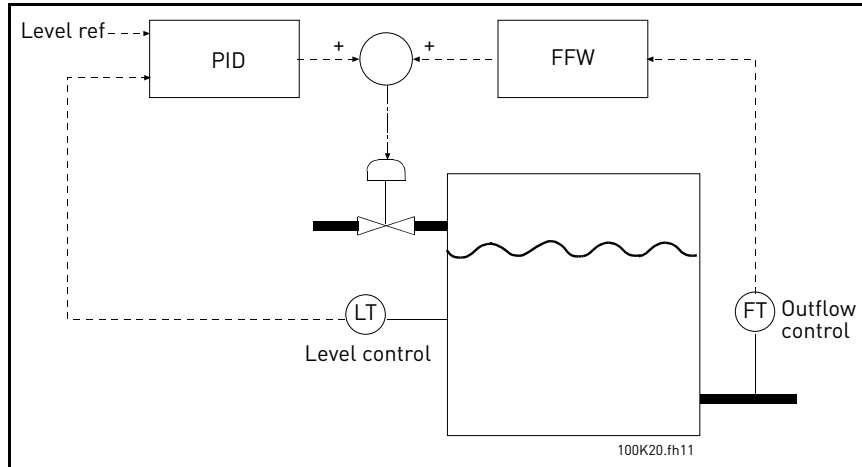

Figure 34. Feedforward control

**P3.12.5.1 ENABLE PROCESS SUPERVISION**

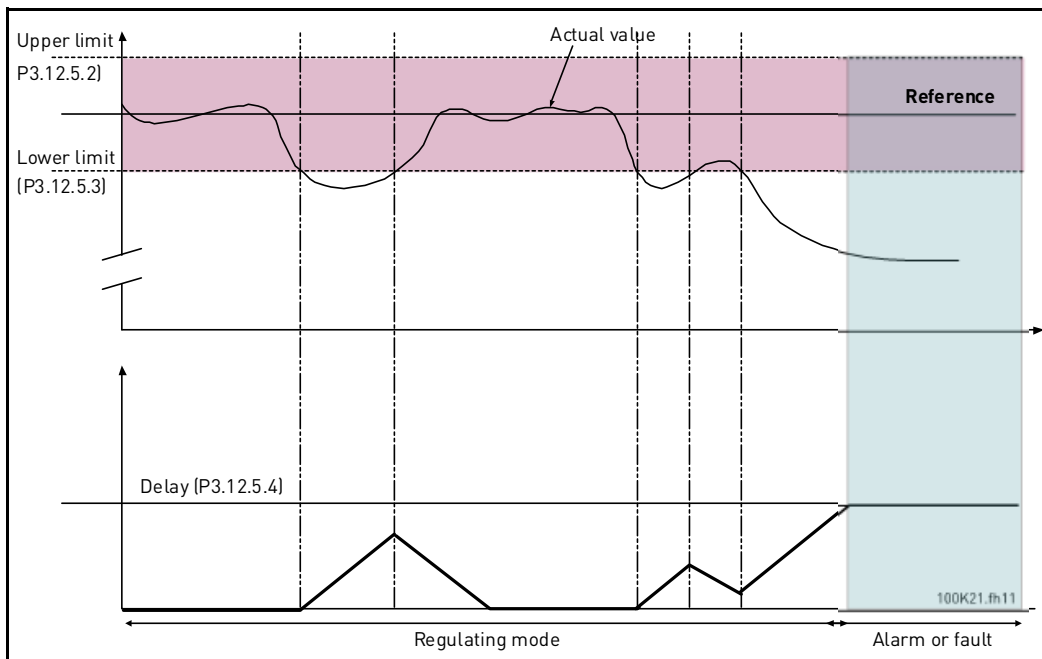
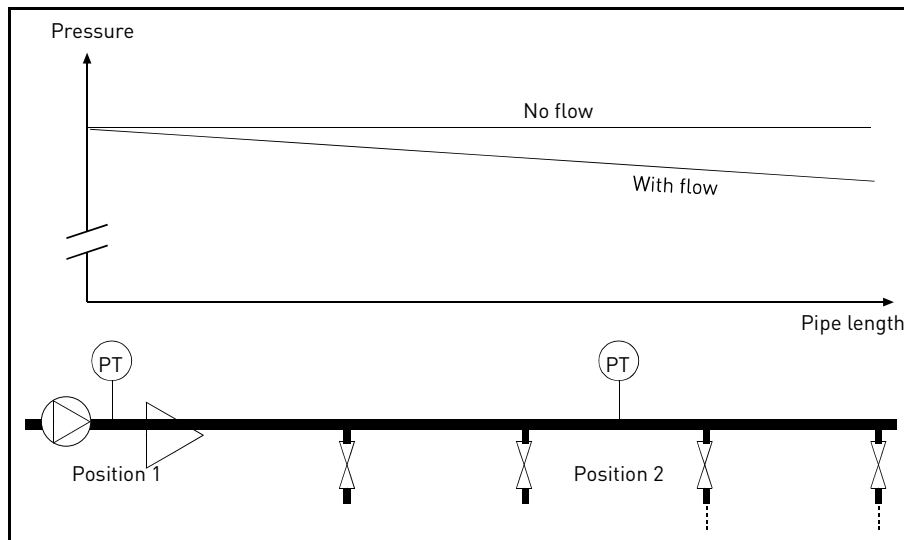

Figure 35. Process supervision

Upper and lower limits around the reference are set. When the actual value goes above or below these a counter starts counting up towards the Delay (P3.12.5.4). When the actual value is within the allowed area the same counter counts down instead. Whenever the counter is higher than the Delay an alarm or fault (depending on the selected response) is generated.

**PRESSURE LOSS COMPENSATION**



*Figure 36. Position of pressure sensor*

If pressurizing a long pipe with many outlets, the best place for the sensor would probably be halfway down the pipe (Position 2). However, sensors might, for example, be placed directly after the pump. This will give the right pressure directly after the pump, but farther down in the pipe the pressure will drop depending on the flow.

**P3.12.6.1 ENABLE SETPOINT 1**  
**P3.12.6.2 SETPOINT 1 MAX COMPENSATION**

The sensor is placed in Position 1. The pressure in the pipe will remain constant when we have no flow. However, with flow, the pressure will drop farther down in the pipe. This can be compensated by raising the setpoint as the flow increases. In this case, the flow is estimated by the output frequency and the setpoint is linearly increased with the flow as in the figure below.

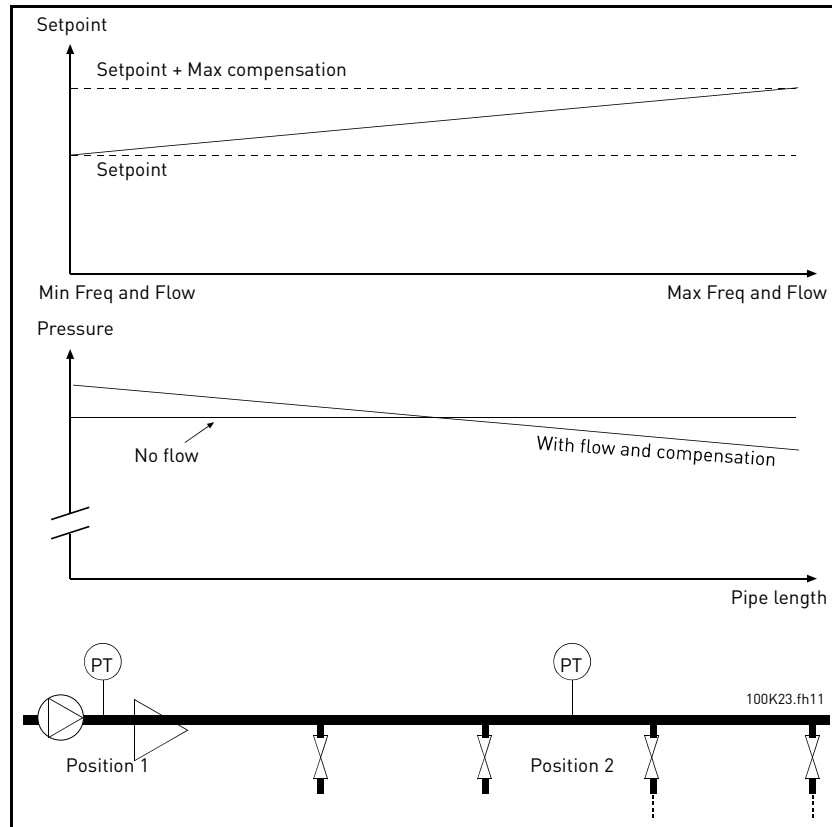

Figure 37. Enable setpoint 1 for pressure loss compensation

### MULTI-PUMP USE

A motor/motors are connected/disconnected if the PID controller is not able to keep the process value or feedback within the defined bandwidth around the setpoint.

Criteria for connecting/adding motors (also see Figure 38):

- Feedback value outside the bandwidth area.
- Regulating motor running at a “close-to-max” frequency (-2Hz)
- Conditions above are fulfilled for a time longer than the bandwidth delay
- There are more motors available

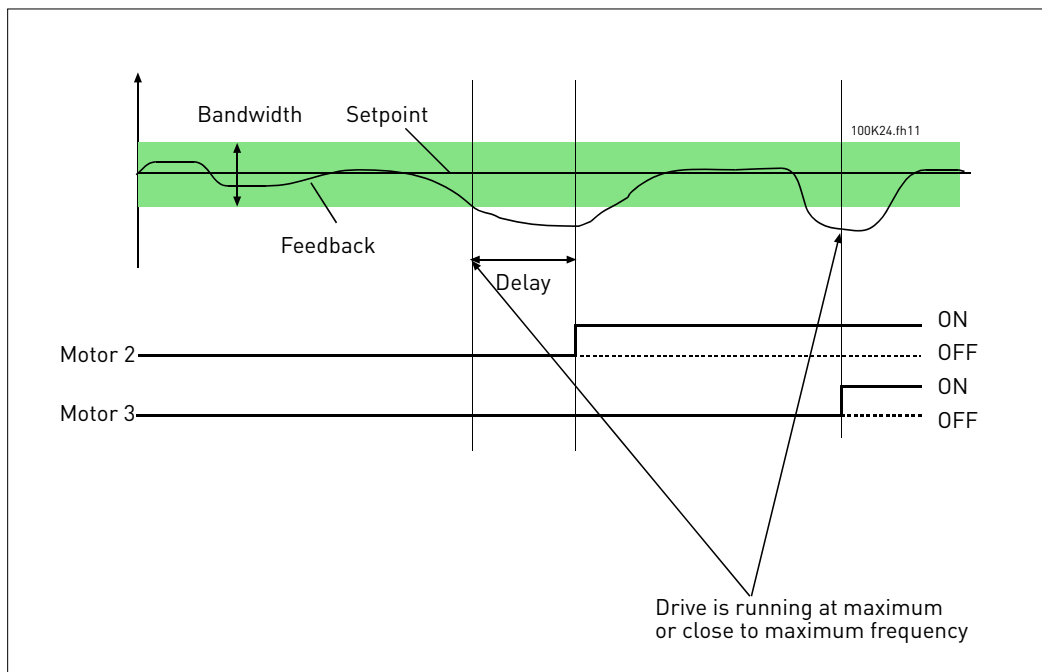

Figure 38.

Criteria for disconnecting/removing motors:

- Feedback value outside bandwidth area.
- Regulating motor running at a “close-to-min” frequency (+2 Hz)
- Conditions above are fulfilled for a time longer than the bandwidth delay
- There are more motors running than the regulating one.

#### P3.14.2 INTERLOCK FUNCTION

Interlocks can be used to tell the Multi Pump system that a motor is not available e.g. because of the motor is removed from the system for maintenance or bypassed for manual control.

Enable this function to use the interlocks. Choose the needed status for each motor by digital inputs (parameters P3.5.1.25 to P3.5.1.28). If the input is closed (TRUE) the motor is available for the Multi Pump system, otherwise it will not be connected by the Multi Pump logic.

**EXAMPLE OF THE INTERLOCK LOGIC:**

If the motor starting order is

**1->2->3->4->5**

Now, the interlock of motor **3** is removed, i.e. the value of parameter P3.5.1.27 is set to FALSE, the order changes to:

**1->2->4->5.**

If motor **3** is taken into use again (changing the value of parameter P3.5.1.27 to TRUE) the system runs on without stopping and motor **3** is placed last in the sequence:

**1->2->4->5->3**

As soon as the system is stopped or goes to sleep mode for the next time, the sequence is updated to its original order.

**1->2->3->4->5**

**P3.14.3 INCLUDE FC**

Selection	Selection name	Description
0	Disabled	Motor 1 (motor connected to frequency converter) is always frequency controlled and not affected by interlocks.
1	Enabled	All motors can be controlled and are affected by interlocks.

**WIRING**

There are two different ways to make the connections depending on whether selection **0** or **1** is set as parameter value.

**Selection 0, Disabled:**

The frequency converter or the regulating motor is not included in the autochange or interlocks logic. The drive is directly connected to motor 1 as in Figure 39 below. The other motors are auxiliary ones connected to the mains by contactors and controlled by relays in the drive.

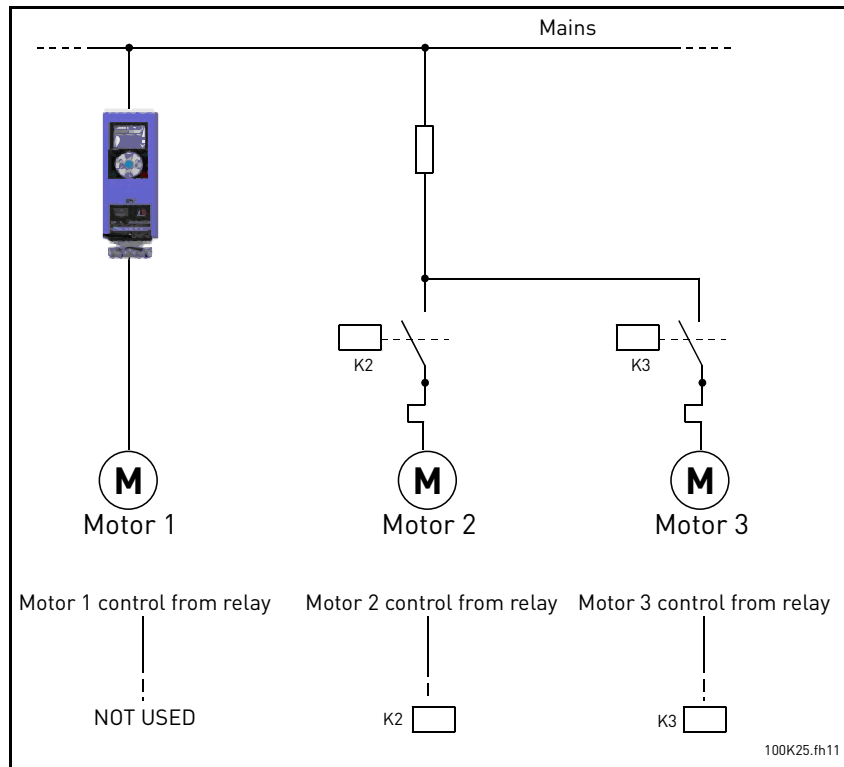

Figure 39.

**Selection 1, Enabled:**

If the regulating motor needs to be included in the autochange or interlock logic make the connection according to Figure 40 below.

Every motor is controlled with one relay but the contactor logic takes care that the first connected motor is always connected to the drive and next to the mains.

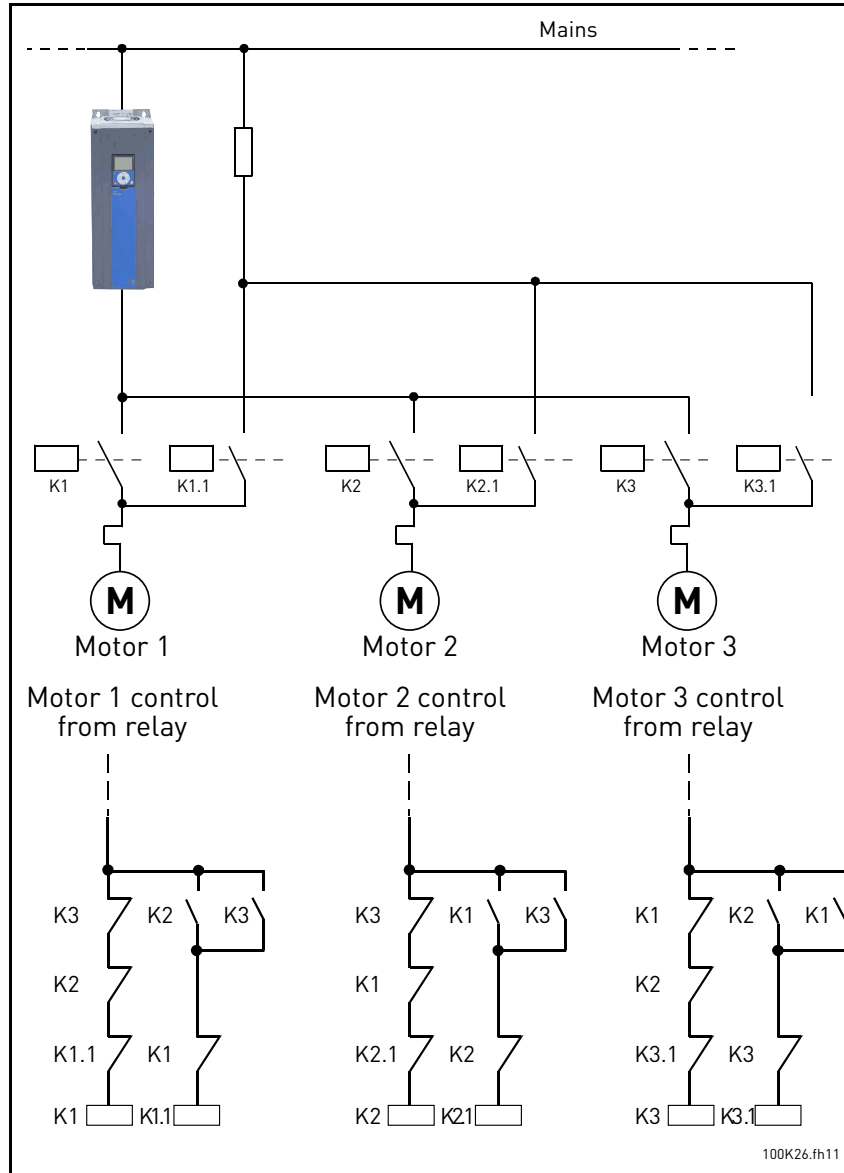

Figure 40.

**P3.14.4 AUTOCHANGE**

Selection	Selection name	Description
0	Disabled	The priority/starting order of the motors is always 1-2-3-4-5 in normal operation. It might have changed during run if interlocks have been removed and added again, but the priority/order is always restored after a stop.
1	Enabled	The priority is changed at certain intervals to get an equal wear on all motors. The intervals of the auto-change can be changed (P3.14.5). You can also set a limit of how many motors are allowed to run (P3.14.7) as well as for the maximum frequency of the regulating drive when the auto-change is done (P3.14.6). If the autochange interval (P3.14.5) has expired, but the frequency and motor limits are not fulfilled, the autochange will be postponed until all conditions are met (this is to avoid e.g. sudden pressure drops because of the system performing an auto-change when there is a high capacity demand at a pump station).

**EXAMPLE:**

In the autochange sequence after the autochange has taken place, the motor with the highest priority is placed last and the others are moved up by one place:

Starting order/priority of motors: **1->2->3->4->5**

--> *Autochange* -->

Starting order/priority of motors: **2->3->4->5->1**

--> *Autochange* -->

Starting order/priority of motors: **3->4->5->1->2**

### 3.7 HVAC APPLICATION - FAULT TRACING

When an unusual operating condition is detected by the AC drive control diagnostics, the drive initiates a notification visible, for example, on the keypad. The keypad will show the code, the name and a short description of the fault or alarm.

The notifications vary in consequence and required action. *Faults* make the drive stop and require reset of the drive. *Alarms* inform of unusual operating conditions but the drive will continue running. *Infos* may require resetting but do not affect the functioning of the drive.

For some faults you can program different responses in the application. See parameter group Protections.

The fault can be reset with the *Reset button* on the control keypad or via the I/O terminal. The faults are stored in the Fault history menu which can be browsed. The different fault codes you will find in the table below.

**NOTE:** When contacting distributor or factory because of a fault condition, always write down all texts and codes on the keypad display.

#### 3.7.1 FAULT APPEARS

When a fault appears and the drive stops examine the cause of fault, perform the actions advised here and reset the fault as instructed below.

1. With a long (1 s) press on the *Reset* button on the keypad or
2. By entering the *Diagnostics* Menu (M4), entering *Reset faults* (M4.2) and selecting *Reset faults* parameter.
3. **For keypad with LCD display only:** By selecting value *Yes* for the parameter and clicking OK.

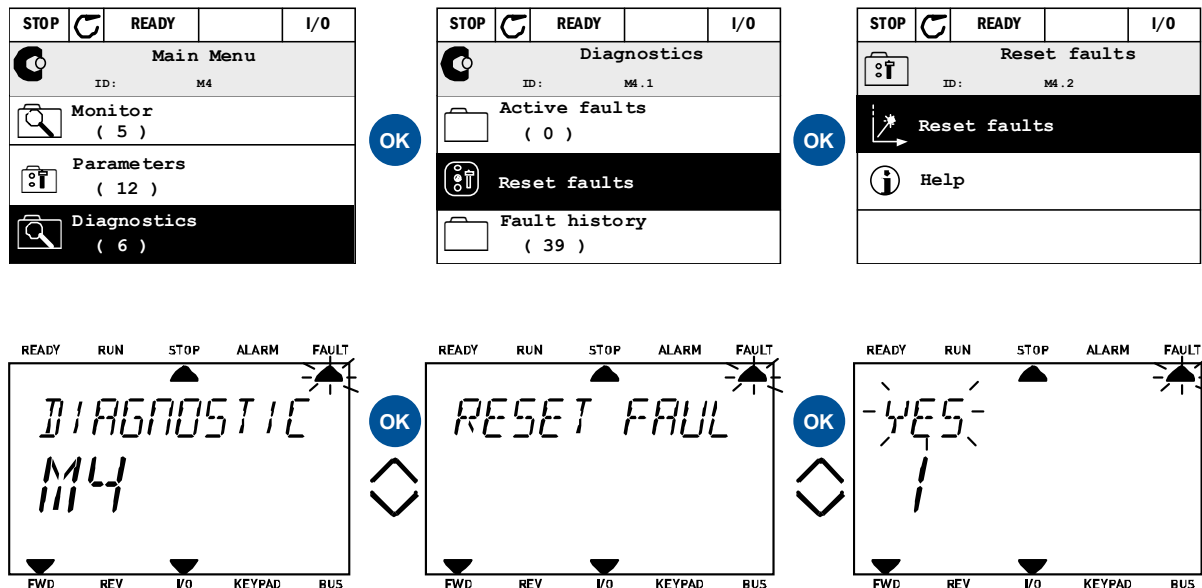

### 3.7.2 FAULT HISTORY

In menu M4.3 Fault history you find the maximum number of 40 occurred faults. On each fault in the memory you will also find additional information, see below.

STOP	READY	I/O
Diagnostics		
ID: M4.1		
Active faults ( 0 )		
Reset faults		
Fault history ( 39 )		

OK

STOP	READY	I/O
Fault history		
ID:		
External Fault	51	
Fault old	891384s	
External Fault	51	
Fault old	871061s	
Device removed	39	
Info old	862537s	

>

STOP	READY	I/O
Device removed		
ID: M4.3.3.2		
Code	39	
ID	380	
State	Info old	
Date	7.12.2009	
Time	04:46:33	
Operating time	862537s	

READY	RUN	STOP	ALARM	FAULT
FAULT HIST				
M4.3				
FWD	REV	I/O	KEYPAD	BUS

OK

READY	RUN	STOP	ALARM	FAULT
COMMUNICAT				
M4.3 1				
FWD	REV	I/O	KEYPAD	BUS

OK

READY	RUN	STOP	ALARM	FAULT
CODE				
65				
FWD	REV	I/O	KEYPAD	BUS

READY	RUN	STOP	ALARM	FAULT
ID				
1065				
FWD	REV	I/O	KEYPAD	BUS

READY	RUN	STOP	ALARM	FAULT
STATE				
2				
FWD	REV	I/O	KEYPAD	BUS

3.7.3 FAULT CODES

Fault code	Fault ID	Fault name	Possible cause	Remedy
1	1	Overcurrent (hardware fault)	AC drive has detected too high a current ( $>4 \cdot I_M$ ) in the motor cable: <ul style="list-style-type: none"> <li>• sudden heavy load increase</li> <li>• short circuit in motor cables</li> <li>• unsuitable motor</li> </ul>	Check loading. Check motor. Check cables and connections. Make identification run. Check ramp times.
	2	Overcurrent (software fault)		
2	10	Overvoltage (hardware fault)	The DC-link voltage has exceeded the limits defined. <ul style="list-style-type: none"> <li>• too short a deceleration time</li> <li>• brake chopper is disabled</li> <li>• high overvoltage spikes in supply</li> <li>• Start/Stop sequence too fast</li> </ul>	Make deceleration time longer. Use brake chopper or brake resistor (available as options). Activate overvoltage controller. Check input voltage.
	11	Overvoltage (software fault)		
3	20	Earth fault (hardware fault)	Current measurement has detected that the sum of motor phase current is not zero. <ul style="list-style-type: none"> <li>• insulation failure in cables or motor</li> </ul>	Check motor cables and motor.
	21	Earth fault (software fault)		
5	40	Charging switch	The charging switch is open, when the START command has been given. <ul style="list-style-type: none"> <li>• faulty operation</li> <li>• component failure</li> </ul>	Reset the fault and restart. Should the fault re-occur, contact the distributor near to you.
7	60	Saturation	Various causes: <ul style="list-style-type: none"> <li>• defective component</li> <li>• brake resistor short-circuit or overload</li> </ul>	Cannot be reset from keypad. Switch off power. DO NOT RE-CONNECT POWER! Contact factory. If this fault appears simultaneously with F1, check motor cables and motor.

Fault code	Fault ID	Fault name	Possible cause	Remedy
8	600	System fault	Communication between control board and power unit has failed.	Reset the fault and restart. Should the fault re-occur, contact the distributor near to you.
	602		Watchdog has reset the CPU	
	603		Voltage of auxiliary power in power unit is too low.	
	604		Phase fault: Voltage of an output phase does not follow the reference	
	605		CPLD has faulted but there is no detailed information about the fault	
	606		Control and power unit software are incompatible	Update software. Should the fault re-occur, contact the distributor near to you.
	607		Software version cannot be read. There is no software in power unit.	Update power unit software. Should the fault re-occur, contact the distributor near to you.
	608		CPU overload. Some part of the software (for example application) has caused an overload situation. The source of fault has been suspended	Reset the fault and restart. Should the fault re-occur, contact the distributor near to you.
	609		Memory access has failed. For example, retain variables could not be restored.	
	610		Necessary device properties cannot be read.	
	647		Software error	Update software. Should the fault re-occur, contact the distributor near to you.
	648		Invalid function block used in application. System software and application are not compatible.	
	649		Resource overload. Error when loading parameter initial values. Error when restoring parameters. Error when saving parameters.	
9	80	Undervoltage (fault)	DC-link voltage is under the voltage limits defined. <ul style="list-style-type: none"> <li>• most probable cause: too low a supply voltage</li> <li>• AC drive internal fault</li> <li>• defect input fuse</li> <li>• external charge switch not closed</li> </ul> <b>NOTE!</b> This fault is activated only if the drive is in Run state.	In case of temporary supply voltage break reset the fault and restart the AC drive. Check the supply voltage. If it is adequate, an internal failure has occurred. Contact the distributor near to you.
	81	Undervoltage (alarm)		
10	91	Input phase	Input line phase is missing.	Check supply voltage, fuses and cable.
11	100	Output phase supervision	Current measurement has detected that there is no current in one motor phase.	Check motor cable and motor.

Fault code	Fault ID	Fault name	Possible cause	Remedy
12	110	Brake chopper supervision (hardware fault)	No brake resistor installed. Brake resistor is broken. Brake chopper failure.	Check brake resistor and cabling. If these are ok, the chopper is faulty. Contact the distributor near to you.
	111	Brake chopper saturation alarm		
13	120	AC drive under-temperature (fault)	Too low temperature measured in power unit's heatsink or board. Heat-sink temperature is under -10°C.	
	121	AC drive under-temperature (alarm)		
14	130	AC drive over-temperature (fault, heatsink)	Too high temperature measured in power unit's heatsink or board. Heat-sink temperature is over 100°C.	Check the correct amount and flow of cooling air. Check the heatsink for dust. Check the ambient temperature. Make sure that the switching frequency is not too high in relation to ambient temperature and motor load.
	131	AC drive over-temperature (alarm, heatsink)		
	132	AC drive over-temperature (fault, board)		
	133	AC drive over-temperature (alarm, board)		
15	140	Motor stalled	Motor is stalled.	Check motor and load.
16	150	Motor overtemperature	Motor is overloaded.	Decrease motor load. If no motor overload exists, check the temperature model parameters.
17	160	Motor underload	Motor is underloaded.	Check load.
19	180	Power overload (short-time supervision)	Drive power is too high.	Decrease load.
	181	Power overload (long-time supervision)		
25		Motor control fault	Start angle identification has failed. Generic motor control fault.	
32	312	Fan cooling	Fan life time is up.	Change fan and reset fan life time counter.
33		Fire mode enabled	Fire mode of the drive is enabled. The drive's protections are not in use.	
37	360	Device changed (same type)	Option board changed for one previously inserted in the same slot. The board's parameter settings are saved.	Device is ready for use. Old parameter settings will be used.
38	370	Device changed (same type)	Option board added. The option board was previously inserted in the same slot. The board's parameter settings are saved.	Device is ready for use. Old parameter settings will be used.

Fault code	Fault ID	Fault name	Possible cause	Remedy
39	380	Device removed	Option board removed from slot.	Device no longer available.
40	390	Device unknown	Unknown device connected (power unit/option board)	Device no longer available.
41	400	IGBT temperature	IGBT temperature (unit temperature + I <sub>2</sub> T) is too high.	Check loading. Check motor size. Make identification run.
43	420	Encoder fault	Encoder 1 channel A is missing.	Check encoder connections. Check encoder and encoder cable. Check encoder board. Check encoder frequency in open loop.
	421		Encoder 1 channel B is missing.	
	422		Both encoder 1 channels are missing	
	423		Encoder reversed	
	424		Encoder board missing	
44	430	Device changed (different type)	Option board changed for one not present in the same slot before. No parameter settings are saved.	Set the option board parameters again.
45	440	Device changed (different type)	Option board added. The option board was not previously present in the same slot. No parameter settings are saved.	Set the option board parameters again.
51	1051	External fault	Digital input.	
52	1052 1352	Keypad communication fault	The connection between the control keypad and frequency converter is broken	Check keypad connection and possible keypad cable
53	1053	Fieldbus communication fault	The data connection between the fieldbus master and fieldbus board is broken	Check installation and fieldbus master.
54	1354	Slot A fault	Defective option board or slot	Check board and slot.
	1454	Slot B fault		
	1654	Slot D fault		
	1754	Slot E fault		
65	1065	PC communication fault	The data connection between the PC and frequency converter is broken	
66	1066	Thermistor fault	The thermistor input has detected an increase of motor temperature	Check motor cooling and load. Check thermistor connection (If thermistor input is not in use it has to be short circuited)
69	1310	Fieldbus mapping error	Non-existing ID number is used for mapping values to Fieldbus Process Data Out.	Check parameters in Fieldbus Data Mapping menu (chapter 3.5.8).
	1311		Not possible to convert one or more values for Fieldbus Process Data Out.	The value being mapped may be of undefined type. Check parameters in Fieldbus Data-Mapping menu (chapter 3.5.8).
	1312		Overflow when mapping and converting values for Fieldbus Process Data Out (16-bit).	

Fault code	Fault ID	Fault name	Possible cause	Remedy
101	1101	Process supervision fault (PID1)	PID controller: Feedback value outside of supervision limits (and the delay if set).	
105	1105	Process supervision fault (PID2)	PID controller: Feedback value outside of supervision limits (and the delay if set).	

Table 57. Fault codes and descriptions

# VACON

DRIVEN BY DRIVES

Find your nearest Vacon office  
on the Internet at:

[www.vacon.com](http://www.vacon.com)

Manual authoring:  
[documentation@vacon.com](mailto:documentation@vacon.com)

Vacon Plc.  
Runsorintie 7  
65380 Vaasa  
Finland

Subject to change without prior notice  
© 2011 Vacon Plc.

Document ID:



Order code:



Rev. E